

Model 515 Flow Computer

Operation Manual

Application CR02

Ratio/Blending Process Controller
for
Volumetric Analog Flowmeters



17 June 2017

Model 515 Flow Computer - Operation Manual

© Contrec Limited 2017

The instructions given herein cover the general description, installation, operation and maintenance of the subject equipment. Contrec Limited. reserves the right, without prior notice, to make engineering refinements that may not be reflected in this manual.

Should any questions arise which cannot be answered specifically by this manual, they should be directed to Contrec Limited for further detailed information and technical assistance.

Contrec Limited will not accept any liability for either direct or consequential damages resulting from the use or misapplication of the contents of this manual.

Part of the software embedded in this product is eCos - Embedded Configurable Operating System, a trademark of Red Hat. Portions created by Red Hat are Copyright © 1998, 1999, 2000 Red Hat, Inc. (<http://www.redhat.com>). All rights reserved

The software in this product was in part provided by Red Hat and any express or implied warranties, including, but not limited to, the implied warranties of merchantability and fitness for a particular purpose are disclaimed. In no event shall the author be liable for any direct, indirect, incidental, special, exemplary, or consequential damages (including, but not limited to, procurement of substitute goods or services; loss of use, data, or profits; or business interruption) however caused and on any theory of liability, whether in contract, strict liability, or tort (including negligence or otherwise) arising in any way out of the use of this software, even if advised of the possibility of such damage.

Contrec Limited

Riverside, Canal Road, Sowerby Bridge,
West Yorkshire HX6 2AY UNITED KINGDOM
Tel: +44 1422 829944 Fax: +44 1422 829945
Email: sales@contrec.co.uk

Website: www.contrec.co.uk

Contrec Systems Pty Ltd

5 Norfolk Avenue Ringwood, Melbourne 3134 AUSTRALIA
Tel: +61 4 413 505 114
Email: info@contrec.com.au

Contrec - USA, LLC

916 Belcher Drive Pelham AL 35124 USA
Tel: +1 (205) 685 3000 Fax: +1 (205) 685 3001
Email: contrec@contrec-usa.com



Publication No: 515-CR02-OM - 17 June 2017



Safety Notice

The information in this safety notice is for the prevention of injury to personnel and damage to the instrument.

The manufacturer assumes no liability for injury or damage caused by misuse of the instrument or for modifications made to the instrument.

Qualified Personnel

The instrument must be installed, operated and serviced by persons who have been properly trained and authorised. Personnel must read and understand this manual prior to installation and operation of the instrument.

Static Hazard

The 500 series flow computer uses high speed CMOS circuitry which is sensitive to static damage. The user should observe accepted safety practices for handling electronic devices, especially during servicing. Once the unit is installed, grounded and interconnected, the chances of static damage are greatly reduced.

Voltage Hazard

Before connecting power to the instrument, ensure that the supply voltage for the AC or DC input is suitable. The AC voltage rating is as stated on the instrument rating plate. Personnel should take all due care to avoid electric shock. For safe operation it is essential to connect a mains safety earth to the A.C. power inlet. Do not operate at altitudes above 2000m.

Welding Hazard

Do not perform electric welding in close proximity to the instrument or its interconnecting cables. If welding in these areas must be performed, disconnect all cables from the instrument. Failure to do so may result in damage to the unit.

Moisture Hazard

To avoid electrical faults and corrosion of the instrument, do not allow moisture to remain in contact with the instrument.

Disconnection Device

When powered from a mains supply this unit requires the provision of a suitable mains isolation device to be accessible near to the installed instrument.

Contents

1 Introduction

| | |
|------------------------|---|
| Features | 1 |
| Overview | 1 |
| Calculations | 2 |
| | 2 |
| Analog Input Scaling | 2 |
| Displayed Information | 2 |
| Main Menu Variables | 3 |
| Communications | 3 |
| Isolated Outputs | 3 |
| Relay Outputs | 3 |
| Software Configuration | 3 |
| Approvals | 4 |

2 Specifications

| | |
|---------------------|---|
| Specification Table | 7 |
|---------------------|---|

3 Installation

| | |
|---|----|
| Panel Mounting | 9 |
| Electrical Connection | 10 |
| Rear Panel Connections | 10 |
| Terminal Designations | 10 |
| Inputs | 11 |
| Analog Input Connections | 11 |
| Logic Input Connection | 12 |
| Outputs | 13 |
| 4-20mA Output Connection | 13 |
| Pulse Output Connection | 14 |
| Control Relays (Alarms) | 14 |
| RC Network for Interference Suppression | 15 |
| Communications | 15 |
| RS-232 Port | 16 |
| RS-485 Port (Optional) | 16 |
| Earthing and Shielding | 17 |

4 Operation

| | |
|--------------------------|----|
| Normal Operation Mode | 19 |
| Default Variable & Total | 19 |
| Status LEDs | 20 |
| Front Panel Keys | 20 |

| | |
|--|----|
| Main Menu Items | 21 |
| Peak Flowrates | 21 |
| Setpoints | 22 |
| Data Logs | 22 |
| Model Information | 23 |
| Process Control Modes | 24 |
| Logic Input Control | 27 |
| Tuning the Control Loop | 27 |
| Tuning the Ratio Trim Control | 28 |
| 5 Instrument Calibration | |
| Introduction | 31 |
| Calibration View Mode | 31 |
| Calibration Set Mode | 32 |
| Changing the Instrument Settings | 33 |
| Calibration Menu Tree | 34 |
| Instrument Settings | 36 |
| Units of Measurement | 36 |
| Parameters | 37 |
| Inputs | 39 |
| Outputs | 41 |
| Alarms | 44 |
| Communications | 45 |
| Time Settings and Data Logging | 47 |
| General Setup Parameters | 50 |
| Test Menu | 51 |
| System Messages | 52 |
| Error Messages | 53 |
| Warning Messages | 53 |
| 6 Communications | |
| Overview | 55 |
| Hardware Interconnection | 55 |
| Protocols | 57 |
| Simple ASCII Protocol | 57 |
| Requests Format | 58 |
| Instrument Responses | 59 |
| Corrupted or Invalid Requests | 63 |
| Modbus RTU Protocol | 63 |
| List of Data Registers | 65 |
| Printer Protocol | 69 |
| Types of Printouts | 70 |
| Printer Data Control | 73 |
| Appendix A Glossary | |
| Glossary | 75 |

Appendix B Model Numbers

| | |
|--|----|
| Product Codes | 77 |
| Custom Version Codes | 78 |
| Application Information Code | 78 |

Appendix C Units of Measurement

| | |
|--|----|
| Available Units of Measurement | 80 |
|--|----|

| | |
|------------------------|----|
| Index | 81 |
|------------------------|----|

List of Figures

| | | |
|----|--|----|
| 1 | Typical Application Diagram | 4 |
| 2 | 500 Series Instrument Panel Mounting | 9 |
| 3 | Rear Panel Connections | 10 |
| 4 | Externally Powered Voltage Transmitter | 11 |
| 5 | Internally Powered Voltage Transmitter | 11 |
| 6 | Externally Powered Current Loop | 12 |
| 7 | Internally Powered Current Loops | 12 |
| 8 | Logic Inputs Connection Diagram | 13 |
| 9 | Output 4-20mA Connection Diagram | 13 |
| 10 | Output Pulse Connection Diagram | 14 |
| 11 | Relay Connection Diagram | 15 |
| 12 | RS-485 Interface Connections | 16 |
| 13 | Logged Data Display Methods | 23 |
| 14 | Calibration Menu Tree Sheet 1 | 34 |
| 15 | Calibration Menu Tree Sheet 2 | 35 |
| 16 | RS-232 Cable Connections to a Computer | 56 |
| 17 | RS-485 Connections | 56 |

Chapter 1

Introduction

Features

- Tailored for volumetric analog input such as vortex flowmeters
- Uses PI Loop Control
- Pump demand contact
- Selection of various control modes
- “Flushing” available via external logic signal
- Allows for cascade trim control when ratio of totals is required
- Allows for non-linear correction
- Selection of second language and user tags
- RTC logging with over 1000 entries
- Pulse width and scaling of pulse output
- 4-20mA retransmission
- Selectable protocols on serial ports including Modbus RTU and Printer output
- Front panel adjustment of 8-24V DC output voltage
- Backlit display with LCD backup

Overview

The 515 CR02 application is a single loop process controller measuring the volume flow in a main and process lines using analog flow inputs. It can operate in local (manual), loop, ratio or blend mode and has a tuning menu to easily determine the Proportional Band and Integral Time values used in the PI control algorithm.

The main and process flows are used to determine the net volume flow. The operator can view the actual ratio and deviation and has the ability to change the controlling setpoint directly from the main menu if access has been authorized.

The PI control of the process flow is via a 4-20mA proportional valve or pump controller. It has integral wind-up protection and a deadband and output ramp time can be programmed to reduce wear on valves and actuators and provide for bumpless operation.

Calculations

There are three types of control modes in which the process flow is dependent on the main flow. These are RATIO, BLEND-1 and BLEND-2 modes where the relationship between the flows are as follows:

Ratio Control Mode.

The process flow is a ratio of the main flow (0 to 400% range).

$$Ratio\% = \frac{P_{flow}}{M_{flow}} \times 100$$

Blend Control Modes.

These modes cater for blending points before and after the main flowmeter. The process flow is a ratio of the net (combined) flow (0 to 80% range).

$$Ratio\% = \frac{P_{flow}}{Net_{flow}} \times 100$$

Analog Input Scaling

The analog inputs in this instrument are scaled by the following general formula:

$$f(A) = P_{min} + (P_{max} - P_{min}) \cdot A^*$$

where:

P_{min} = minimum point (equivalent to offset)

P_{max} = maximum point ($P_{max} - P_{min}$ is equivalent to span)

A^* = normalised signal (0 to 1) with correction applied for a flow input

Correction Type

- **LINEAR:** $A^* = A$ when the instrument is not required to apply correction
- **NON-LINEAR:** $A^* = A_c$ when the instrument applies correction from the points in the correction table

Displayed Information

The front panel display shows the current values of the input variables and the results of the calculations.

The instrument can be supplied with a real-time clock for data logging of over 1000 entries of the variables as displayed on the main menu.

Main Menu Variables

| Main Menu Variables | Default Units | Variable Type |
|----------------------------|---------------------|---------------|
| Net Volume | m ³ | Total |
| Net Flowrate | m ³ /min | Rate |
| Main Line Volume | m ³ | Total |
| Main Line Flowrate | m ³ /min | Rate |
| Process Line Volume | m ³ | Total |
| Process Line Flowrate | m ³ /min | Rate |
| Process Ratio | % | Rate |
| Process Control Output | % | Rate |
| Process Flowrate Deviation | % | Rate |

Refer to [Available Units of Measurement](#) on page 80 for the list of available units.

Communications

There are currently two communication ports available as follows:

- RS-232 port
- RS-485 port (optional)

The ports are available for remote data reading, printouts and for initial application loading of the instrument.

Isolated Outputs

The opto-isolated outputs can re-transmit any main menu variable. The type of output is determined by the nature of the assigned variable. Totals are output as pulses and rates are output as 4-20mA signals. One output is standard, a second output is available as an option.

Relay Outputs

The relay output 1 provides a pump demand contact and the other relays can be used as a fully programmable alarms for any rate type variable. Two relays are standard with an additional two available in the advanced option.

Software Configuration

The instrument can be further tailored to suit specific application needs including units of measurement, custom tags, second language or access levels. A distributor can configure these requirements before delivery.

Instrument parameters including units of measurement can be programmed in the field, according to the user access levels assigned to parameters by the distributor.

All set-up parameters, totals and logged data are stored in non-volatile memory with at least 30 years retention.

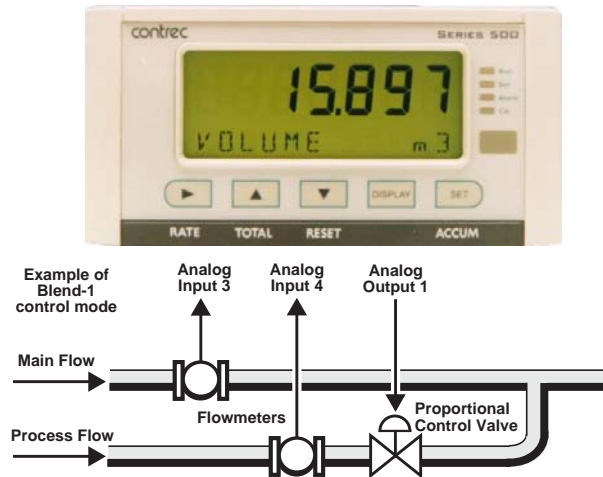

Figure 1 Typical Application Diagram

Approvals

This instrument conforms to the EMC-Directive of the Council of European Communities 2014/30/EU, the LVD safety directive 2014/35/EU and the following standards:

- *EN61326:2013* Electrical equipment for measurement, control and laboratory use – EMC requirements: Industrial Environment.
- *EN61010:2010* Safety requirements for electrical equipment for measurement, control, and laboratory use.

In order to comply with these standards, the wiring instructions in **Chapter 3 - Installation** must be followed.

FCC Declaration

This equipment has been tested and found to comply with the limits for a Class A digital device, pursuant to Part 15 of the FCC Rules. These limits are designed to provide reasonable protection against harmful interference when the equipment is operated in a commercial environment. This equipment generates, uses, and can radiate radio frequency energy and, if not installed and used in accordance with the instruction manual, might cause harmful interference to radio communications. Operation of this equipment in a residential area is likely to cause harmful interference, in which case the user will be required to correct the interference at his own expense.

Properly shielded and grounded cables and connectors must be used in order to meet FCC emission limits. Contrec Ltd is not responsible for any radio or television interference caused by using other than recommended cables and connectors or by unauthorized changes or modifications to this equipment. Unauthorized changes or modifications could void the user's authority to operate the equipment.

This device complies with Part 15 of the FCC Rules. Operation is subject to the following two conditions: (1) this device might not cause harmful interference, and (2) this device must accept any interference received, including interference that might cause undesired operation.

Chapter 2

Specifications

Specification Table

| Operating Environment | |
|----------------------------------|--|
| Temperature | -20°C to +60°C (conformal coating) +5°C to +40°C (no coating) |
| Humidity | 0 to 95% non condensing (conformal coating) 5% to 85% non condensing (no coating) |
| Power Supply | 100-240 V AC (+/-10%) 50-60 Hz (+/-10%) or 12-28 V DC |
| Consumption | 6W (typical) |
| Protection | Sealed to IP65 (Nema 4X) when panel mounted |
| Dimensions (panel option) | 147mm (5.8") width 74mm (2.9") height 167mm (6.6") depth |

| Display | |
|--------------------|--|
| Type | Backlit LCD with 7-digit numeric display and 11-character alphanumeric display |
| Digits | 15.5mm (0.6") high |
| Characters | 6mm (0.24") high |
| LCD Backup | Last data visible for 15min after power down |
| Update Rate | 0.3 second |

| Non-volatile Memory | |
|---------------------|------------------------|
| Retention | > 30 years |
| Data Stored | Setup, Totals and Logs |

| Approvals | |
|---------------------|---|
| Interference | CE compliance |
| Enclosure | IECEX, ATEX and CSA approved enclosures available for hazardous areas |

| Real Time Clock (Optional) | |
|----------------------------|--------------------------------------|
| Battery Type | 3 volts Lithium button cell (CR2032) |
| Battery Life | 5 years (typical) |

| Analog Input (General) | |
|------------------------|--|
| Overcurrent | 100mA absolute maximum rating |
| Update Time | < 1.0 sec |
| Configuration | 4-20mA, 0-5V and 1-5V input |
| Non-linearity | Up to 20 correction points (some inputs) |

| 4-20mA Input | |
|------------------|---|
| Impedance | 100 Ohms (to common signal ground) |
| Accuracy | 0.05% full scale (20°C) 0.1% (full temperature range, typical) |

| 0-5 or 1-5 Volts Input | |
|------------------------|---|
| Impedance | 10MOhms (to common signal ground) |
| Accuracy | 0.05% full scale (20°C) 0.1% (full temperature range, typical) |

| Logic Inputs | |
|--------------------|--|
| Signal Type | CMOS, TTL, open collector, reed switch |
| Overvoltage | 30V maximum |

| Relay Output | |
|-----------------------|--|
| No. of Outputs | 2 relays plus 2 optional relays |
| Voltage | 250 volts AC, 30 volts DC maximum (solid state relays use AC only) |
| Current | 3A maximum |

| Communication Ports | |
|---------------------|---------------------------------------|
| Ports | RS-232 port RS-485 port (optional) |
| Baud Rate | 2400 to 19200 baud |
| Parity | Odd, even or none |
| Stop Bits | 1 or 2 |
| Data Bits | 8 |
| Protocols | ASCII, Modbus RTU, Printer* |

| Transducer Supply | |
|-------------------|---------------------------------|
| Voltage | 8 to 24 volts DC, programmable |
| Current | 70mA @ 24V, 120mA @ 12V maximum |
| Protection | Power limited output |

Isolated Output

| | |
|-----------------------|---|
| No. of Outputs | 1 configurable output (plus 1 optional) |
| Configuration | Pulse/Digital or 4-20mA output |

Pulse/Digital Output

| | |
|--------------------|---|
| Signal Type | Open collector |
| Switching | 200mA, 30 volts DC maximum |
| Saturation | 0.8 volts maximum |
| Pulse Width | Programmable: 10, 20, 50, 100, 200 or 500ms |

4-20mA Output

| | |
|-------------------|---|
| Supply | 9 to 30 volts DC external |
| Resolution | 0.05% full scale |
| Accuracy | 0.05% full scale (20°C) 0.1% (full temperature range, typical) |

*Important: Specifications are subject to change without notice.
Printer protocol is available only if RTC option is installed.*

Chapter 3

Installation

Panel Mounting

The instrument should be located in an area with a clean, dry atmosphere that is also relatively free of shock and vibration.

The standard mounting procedure is panel mounting in a cutout that is 139mm wide by 67mm high. Two side clips secure the unit into the panel.

Figure 2 shows the panel mounting requirements for the 500 Series Instrument.

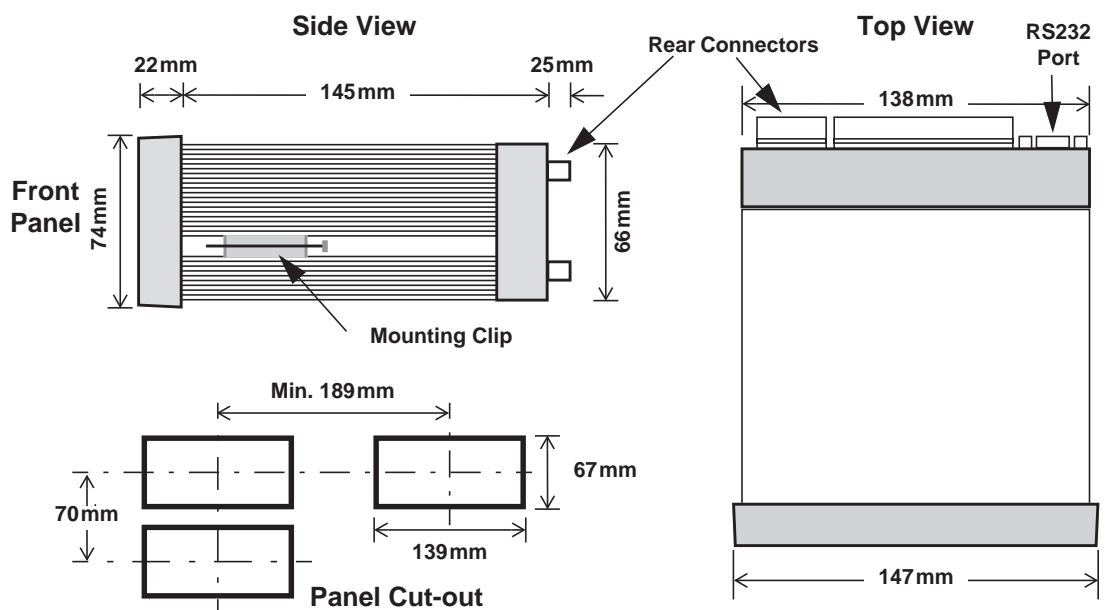

Figure 2 500 Series Instrument Panel Mounting

Electrical Connection

Rear Panel Connections

Figure 3 shows the connections on the rear panel of the instrument.

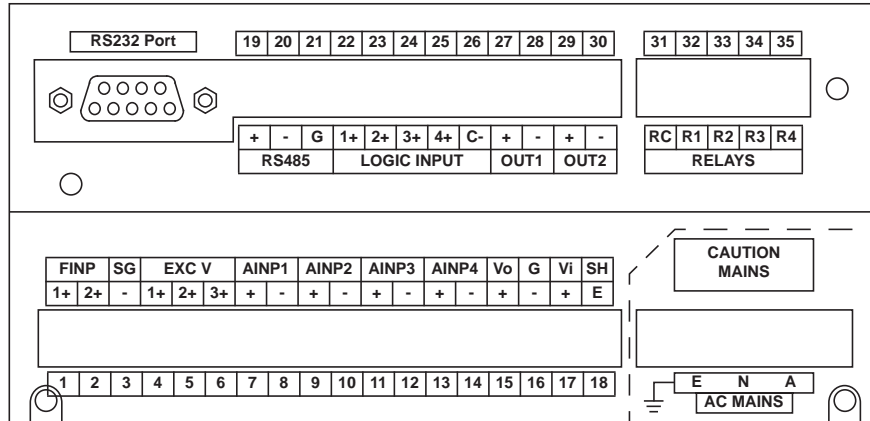

Figure 3 Rear Panel Connections

Terminal Designations

| Terminal Label | Designation | Comment | Terminal Label | Designation | Comment | |
|----------------|-------------|-----------------------|------------------------|-------------|-----------------|-------------------|
| 1 | FINP 1+ | Frequency Input 1+ | Not used | 19 | RS485 + | RS485 (+) |
| 2 | FINP 2+ | Frequency Input 2+ | Not used | 20 | RS485 - | RS485 (-) |
| 3 | SG - | Signal ground | | 21 | RS485 G | RS485 ground |
| 4 | EXC V 1+ | Excitation Term 1+ | Not used | 22 | LOGIC INPUTS 1+ | Switch 1 |
| 5 | EXC V 2+ | Excitation Term 2+ | Not used | 23 | LOGIC INPUTS 2+ | Switch 2 |
| 6 | EXC V 3+ | Excitation Term 3+ | Not used | 24 | LOGIC INPUTS 3+ | Switch 3 |
| 7 | AINP1 + | Analog Input ch 1 (+) | Not used | 25 | LOGIC INPUTS 4+ | Switch 4 |
| 8 | AINP1 - | Analog Input ch 1 (-) | Not used | 26 | LOGIC INPUTS C- | Signal ground |
| 9 | AINP2 + | Analog Input ch 2 (+) | Not used | 27 | OUT1 + | Output ch 1 (+) |
| 10 | AINP2 - | Analog Input ch 2 (-) | Not used | 28 | OUT1 - | Output ch 1 (-) |
| 11 | AINP3 + | Analog Input ch 3 (+) | Main Flow Input | 29 | OUT2 + | Output ch 2 (+) |
| 12 | AINP3 - | Analog Input ch 3 (-) | | 30 | OUT2 - | Output ch 2 (-) |
| 13 | AINP4 + | Analog Input ch 4 (+) | Process Flow Input | 31 | RELAYS RC | Relay common |
| 14 | AINP4 - | Analog Input ch 4 (-) | | 32 | RELAYS R1 | Relay 1 |
| 15 | Vo + | 8-24 volts DC output | Overload protected | 33 | RELAYS R2 | Relay 2 |
| 16 | G - | DC Ground | | 34 | RELAYS R3 | Relay 3 |
| 17 | Vi + | DC power input | DC power in 12-28V | 35 | RELAYS R4 | Relay 4 |
| 18 | SH E | Shield terminal | | | | |
| E | AC MAINS E | Mains ground | AC power in 100-240VAC | | | |
| N | AC MAINS N | Mains neutral | | | | |
| A | AC MAINS A | Mains active | | | | |
| | | | | RS232 port | | 9-pin serial port |

Inputs

Analog Input Connections

All analog inputs can accept DC signals ranging from 0-5V, 1-5V and current signals from 4 to 20mA.

CAUTION

Applying levels of input current above the absolute maximum rating (100mA) may cause permanent damage to the input circuitry.

0-5 and 1-5 Volt Inputs

For externally powered voltage transmitters, connect each transmitter to a pair of input terminals as shown in Figure 4. Refer to **Terminal Designations** on page 10 for specific terminal numbers for this application.

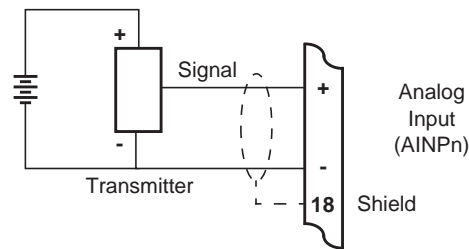

Figure 4 Externally Powered Voltage Transmitter

Connect internally powered voltage transmitters as shown in Figure 5.

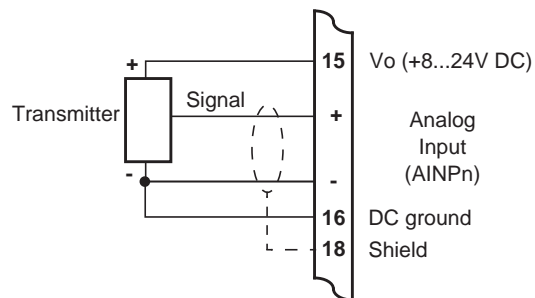

Figure 5 Internally Powered Voltage Transmitter

4-20mA Inputs

For externally powered current loops, connect each transmitter to a pair of input terminals as shown in Figure 6. **Terminal Designations** on page 10 for specific terminal numbers for this application.

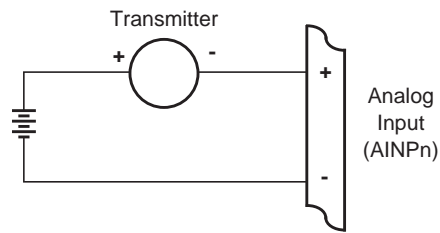

Figure 6 Externally Powered Current Loop

The internal overload-protected power supply has sufficient power for three current loops at 24 V DC (more current loops can be supplied by using a reduced voltage setting). Connect internally powered current loops as shown in Figure 7.

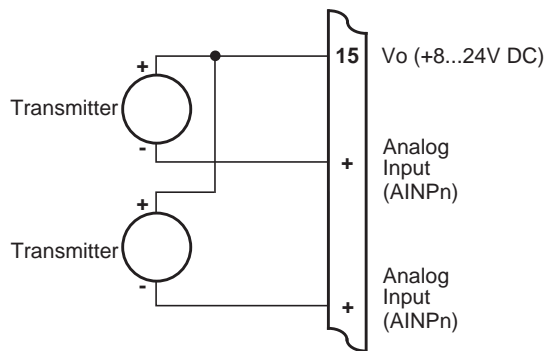

Figure 7 Internally Powered Current Loops

Logic Input Connection

These inputs are designed to be connected to CMOS, TTL, open collector signals or a voltage free contact switch. A minimum activation time of 300ms is required to guarantee reading of an input.

It is possible to read the status of all the logic inputs via a Modbus register even if they are not used for a control purpose in the application.

A remote push-button key can be connected to the Logic Inputs as shown below. **Logic Input Control** on page 27 describes the function of the inputs.

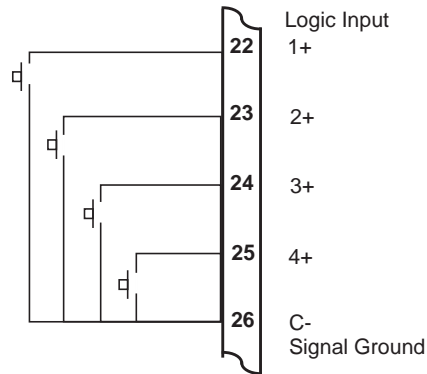

Figure 8 Logic Inputs Connection Diagram

Outputs

The advanced option for the instrument provides two opto-isolated output ports. Either or both can be used for 4-20mA or pulse outputs.

CAUTION

Due to the dual-purpose nature of the outputs, take care not to set the output as an open collector pulse type signal when connected to a 4-20mA loop circuit.

4-20mA Output Connection

Figure 9 shows the connections for a 4-20mA output. Output channel 1 uses terminals 27 (+) and 28 (-), output channel 2 uses terminals 29 (+) and 30 (-).

Maximum Load Resistance = (Supply - 9) / 0.02 ohms

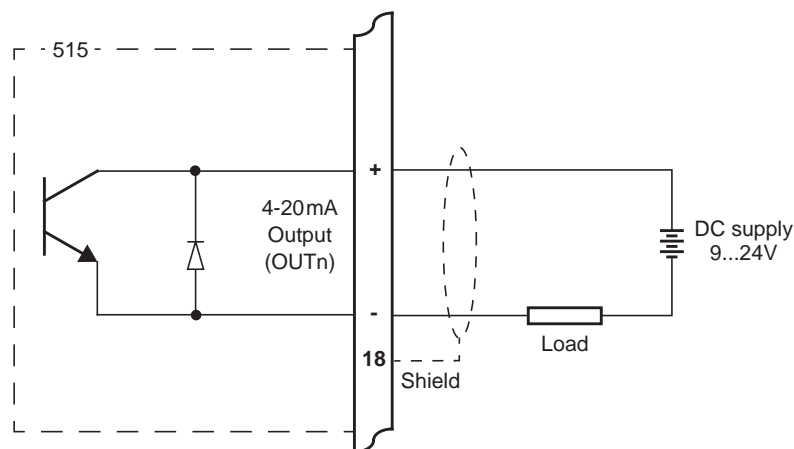

Figure 9 Output 4-20mA Connection Diagram

Pulse Output Connection

Figure 10 shows a connection example for a pulse output. Output channel 1 uses terminals 27 (+) and 28 (-). Output channel 2 uses terminals 29 (+) and 30 (-).

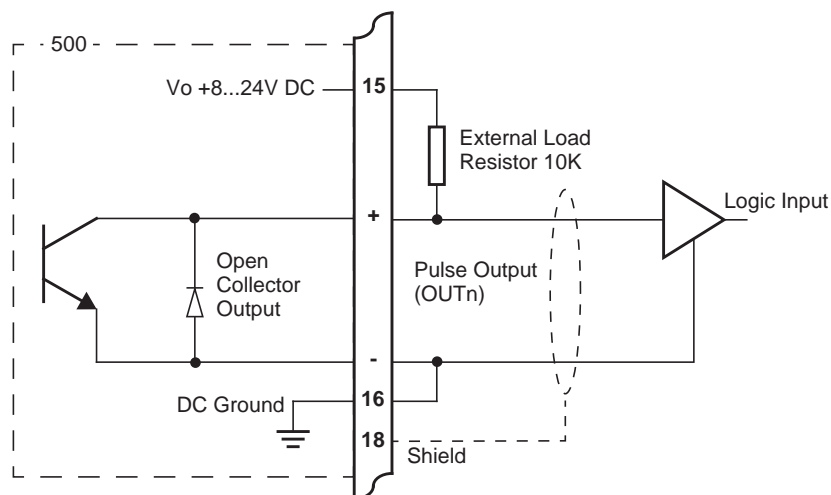

Figure 10 Output Pulse Connection Diagram

Control Relays (Alarms)

The relay output 1 is dedicated as a pump demand contact. It disconnects the pump if the instrument operates in **RATIO** or **BLEND** mode and either the Ratio Setpoint is set to zero, or Inhibit Input is active, or the main flow stays at zero longer than preprogrammed delay. The other relays can be used for alarms on any rate type variable. Two relays are standard with an additional two available in the advanced option.

The operation of alarm relay(s) can be set to various modes as described in [Alarms](#) on page 44.

There is also an equipment failure alarm option. This alarm can have normally closed (open) contacts which open (close) when the instrument displays any error message as listed in [Error Messages](#) on page 53, or if there is a loss of power to the instrument.

The output characteristics of the relays are:

Maximum Voltage 30 volts DC or 250 volts AC
Maximum Current 3A

Note: Solid state relays use AC voltage only.

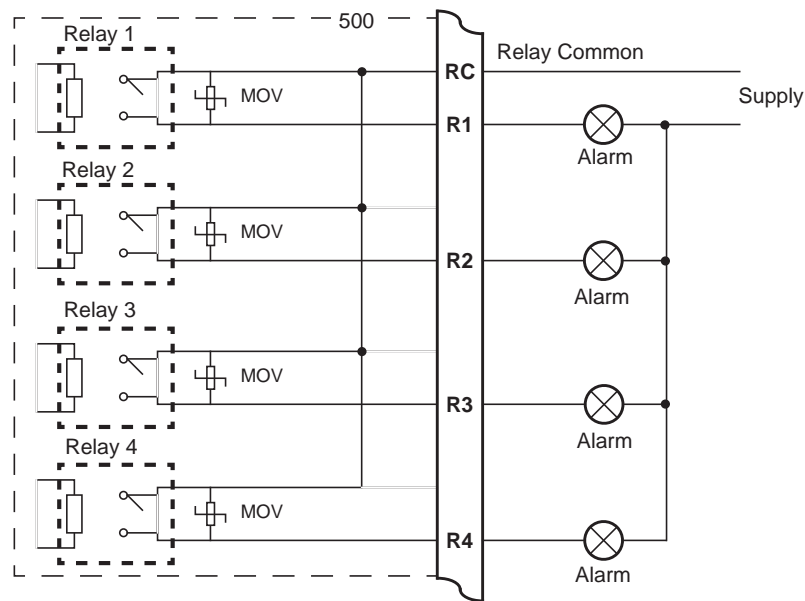

Figure 11 Relay Connection Diagram

RC Network for Interference Suppression

When driving highly inductive loads with the relay outputs, it is recommended to use RC suppression networks (often called “Snubbers”) for the following reasons:

- To limit the amount of electrical noise caused by arcing across the contacts, which may, in extreme cases, cause the microprocessor to act erratically.
- To protect the relay contacts against premature wear through pitting.

RC suppression networks consist of a capacitor and series resistor and are commonly available in the electrical industry. The values of R and C are dependent entirely on the load. However, if the user is unsure of the type of snubber to use, values of $0.25\mu\text{F}$ and 100Ω will usually suffice. Note that only mains-approved RC suppression networks should be used.

The basic principle of the operation is that the capacitor prevents a series of sparks arcing across the contact as the contact breaks. The series resistor limits the current through the contact when the contact first makes.

Communications

The communication protocols are described in [Communications](#) on page 55.

RS-232 Port

The RS-232 port has a 9-pin DB female connector and has the following pinout:

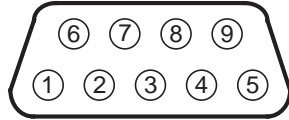

| | |
|-------|----------------------|
| Pin 1 | Not used |
| Pin 2 | Transmit (TxD) |
| Pin 3 | Receive (RxD) |
| Pin 4 | Not used |
| Pin 5 | Ground |
| Pin 6 | Not used |
| Pin 7 | Handshake line (CTS) |
| Pin 8 | RTS Out |
| Pin 9 | Not used |

Note: The instrument does not require a null-modem cable for connection to a personal computer. Refer to [Hardware Interconnection](#) on page 55 for cable termination requirements.

RS-485 Port (Optional)

Up to 32 units can be connected to a common RS-485 bus. Each unit has a unique address that the host computer uses to identify each instrument.

Figure 12 shows the connection of several instruments to a computer using the RS-485 port.

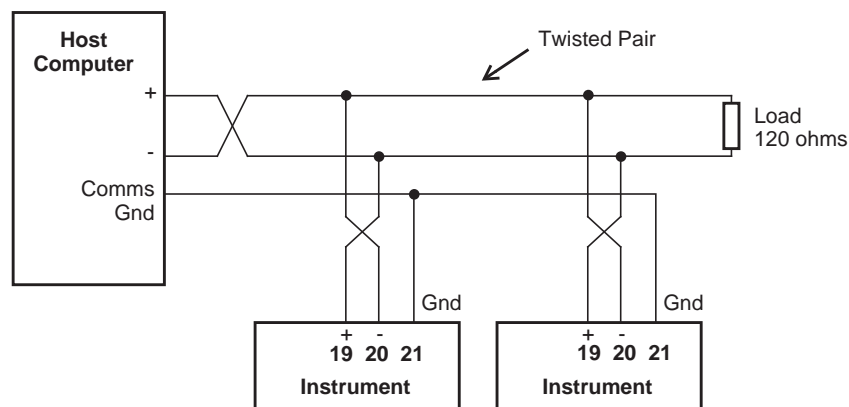

Figure 12 RS-485 Interface Connections

Earthing and Shielding

It is a good practice to use shielded cable for all signal connections to the instrument. Care must be taken to separate signal cables from power cables to minimize interference.

Overall earth should be connected at the instrument end only. This connection should be as short as possible and connected to the earthing point on the rear terminal at pin 18.

Chapter 4

Operation

Normal Operation Mode

In normal operation mode, you press the buttons on the front panel to display the values recorded and calculated by the instrument. There are five categories of information that the instrument can display:

- Totals
- Rates
- Process variables
- Control setpoints
- Instrument settings

For each total, there is an associated rate as follows:

| Total | Rate |
|---------------------|-----------------------|
| Net Volume | Net Flowrate |
| Main Line Volume | Main Line Flowrate |
| Process Line Volume | Process Line Flowrate |

Default Variable & Total

In some applications, a particular variable or particular set of total and rate is of more interest than others, and for this reason a default variable and a default total (and its associated rate) can be assigned during instrument calibration. These defaults are used in the following ways:

- The default total (and rate) determines what comes first in the sequence of totals and rates that are displayed with the front panel keys.
- The default variable determines what the display returns to if the display timeout option is enabled and no buttons are pressed for the selected period (usually 30 seconds). It also determines what is displayed on power up.

Status LEDs

The status LEDs illuminate to show the following conditions:

| | | | |
|--------------------------|-------|--------------|---|
| <input type="checkbox"/> | Run | Run | The 'Inhibit Process Flow' feature is active. |
| <input type="checkbox"/> | Set | Set | The instrument is in Calibrate Set mode. |
| <input type="checkbox"/> | Alarm | Alarm | The instrument has an error, as indicated on the display panel. |
| <input type="checkbox"/> | Cal | Cal | The instrument is in Calibrate View mode. |

Front Panel Keys

For most actions with the front panel keys, you can hold a key to scroll through the values or options, instead of repeatedly pressing the key.

RATE Press the **RATE** key to display the rate that is associated with the currently displayed total. If an item other than a rate or total is displayed, press the **RATE** key to display the “default rate”. When a rate is displayed, press or hold the **RATE** key to display the other rate variables in turn.

TOTAL Press the **TOTAL** key to display the total that is associated with the currently displayed rate. If an item other than a rate or total is displayed, press the **TOTAL** key to display the “default total”. When a total is displayed, press or hold the **TOTAL** key to display the other total variables in turn.

RESET Use the **RESET** key to clear the totals or to initiate a printout if the printer option has been selected. The printout is activated with a single press while the Total Reset function has different operation modes that are selectable during instrument calibration as follows:

- NONE - The user cannot reset the non-accumulated totals.
- INSTANT - When the user presses the **RESET** key, the instrument resets all non-accumulated totals.
- DELAYED - When the user holds the **RESET** key for two seconds, the instrument resets all non-accumulated totals.

The instrument generates three beeps when it resets the totals and two beeps when a printout is started.

DISPLAY Press the **DISPLAY** key to step or scroll through the main menu items.

ACCUM Hold the **ACCUM** key to display the accumulated value for the currently displayed total or to display the peak value for the currently displayed flowrate. See below for further details of peak flowrates.

Main Menu Items

The main menu in this instrument consists of the following items. The **DISPLAY** key is used to step or scroll through the list.

| DISPLAY ↓ | Description | Options |
|---------------------|---|--|
| N-VOL | Net volume | Hold the ACCUM key to display accumulated total |
| N-FLOW | Net flowrate | Hold the ACCUM key to display peak value |
| M-VOL | Main line volume | Hold the ACCUM key to display accumulated total |
| M-FLOW | Main line flowrate | Hold the ACCUM key to display peak value |
| P-VOL | Process line volume | Hold the ACCUM key to display accumulated total |
| P-FLOW | Process line flowrate | Hold the SET key to display (or edit) the controlling setpoint |
| RATIO | Process ratio | Hold the SET key to display (or edit) the controlling setpoint |
| P-CTRL | Process control output | Hold the SET key to display (or edit) the controlling setpoint |
| DEVIAT | Process flowrate deviation | Hold the SET key to display (or edit) the controlling setpoint |
| REPORT PRINT | Only shown if print option is selected | Hold the SET key to print log report as defined in the TM/LOG section of calibration |
| LOGGED DATA | Only shown if real-time clock option is installed | Hold the SET key to display data logs as described in Data Logs on page 22 |
| MODEL INFO | | Hold the SET key to display the Model information as described in Model Information on page 23 |
| CAL MENU | | Hold the SET key to enter Calibration View mode as described in Calibration View Mode on page 31 |

Peak Flowrates

The peak value for the currently displayed flowrate can be viewed by holding the **ACCUM** key. The peak value is the average over a 15 minute period since the last reset of totals or powering on of the instrument. Dashes are shown for this value after a reset or power on until the first averaging period has passed.

Setpoints

SET Hold the **SET** key to display (or edit) the controlling setpoint while viewing one of the process variables. The display of the setpoint will change from view mode to edit mode after 2 seconds if access has been enabled in calibration. Once in edit mode the **Set** indicator will illuminate and the setpoint values are changed in exactly the same way as in calibration set mode.

Data Logs

For instruments with the Original CPU Type (see model number codes) the instrument can store a total of 100 log entries which can be programmed to a combination of the above intervals.

For instruments with the Standard CPU Type (see model number codes) the instrument can store a total of 1530 log entries which are distributed over the log intervals as follows:

- 800 hourly logs
- 400 daily logs
- 200 weekly logs
- 100 monthly logs
- 30 yearly logs

Note that the totals are saved as accumulated totals.

If the number of log entries exceeds the programmed number for a particular time interval, the oldest log entry is overwritten by the newest one for that time interval.

The log entries are recorded at the following times:

HOUR 00 minutes each hour
DAY 00 hours and 00 minutes each day
WEEK 00 hours and 00 minutes each Monday
MONTH 00 hours and 00 minutes on the first day of the month
YEAR 00 hours and 00 minutes on the first day of the year.

View Data Logs

Use the following procedure to view the data that has been logged by the instrument:

1. Press the **DISPLAY** key to scroll through the menu to the **LOGGED DATA** prompt.
2. Hold the **SET** key.

The system displays the hourly log. The timebase and number of the log are shown, for example LH-001.

3. While holding the **DISPLAY** key use the **RESET** key to print the data for the displayed log if the printer option has been selected.

The following example shows the hourly log number 006 at 15:00 (3:00 pm) on 16 January 2016. The day and month alternate with the year in the bottom right hand corner.



Figure 13 shows how to display the logged data.

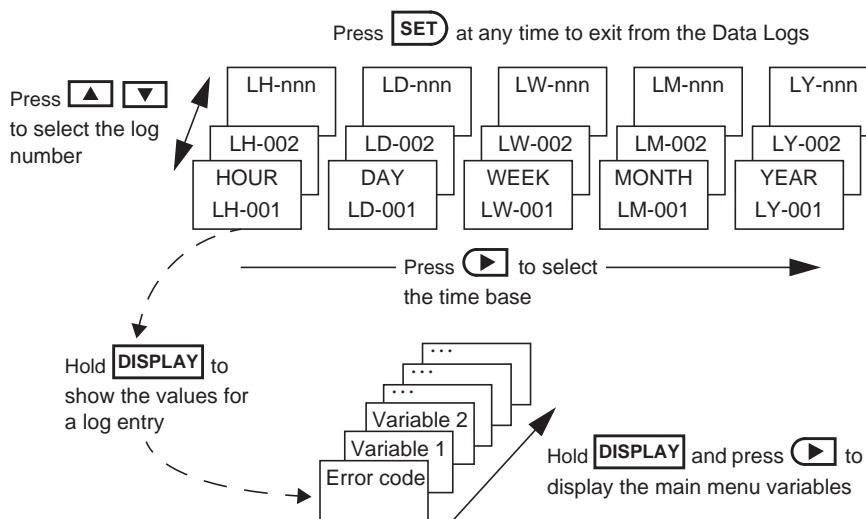

Figure 13 Logged Data Display Methods

Model Information

The model information items display the hardware, software and application versions of the instrument. This information is mainly for service personnel.

| DISPLAY ↓ | Description |
|--------------------------|--|
| 2-1--5- 515 MODEL | The hardware model code. Refer to Product Codes on page 77 for more information. |
| - - - - FF CR02 INPUT | The Application number and the assignment of the inputs. Refer to Application Information Code on page 78 for more information. |

| <div style="border: 1px solid black; padding: 2px; display: inline-block;">DISPLAY</div> ↓ | Description |
|---|--|
| 3.0.000 500PM VERS | The version of 500-Series Program Manager from which the application software was compiled. |
| 026357 CUSTOM VERS | The Customer version code for this installation. Refer to Custom Version Codes on page 78 for more information. |
| 123456 ABC123 S/N | The instrument serial number and unit tag. The serial number is on the top line and unit tag is on the bottom left. Both items are entered when the instrument application software is initially loaded. The default unit tag is UNIT-1. |
| 16-15 EDITED 27/08 2016 | The time and date when the calibration of the instrument was last edited. The format of the time and date is the same as for the data logs. This example shows 16:15 (4:15pm) on the 27th August 2016. This function is available only if the instrument has the real time clock option. |

Press **SET** at any time to exit from the Model information.

Process Control Modes

This instrument can operate in several process control modes including:

- Local (manual) mode
- Loop mode
- Tune mode (only available in calibration set mode)
- Ratio mode
- Blend-1 mode (for blending point after main flowmeter)
- Blend-2 mode (for blending point before main flowmeter)

In all of these modes, except Blend-2, the Net flow is the combination of the Main and Process flows. In Blend-2 the Main flow equals the Net flow.

The pump demand relay 1 disconnects the pump if the instrument operates in RATIO or BLEND mode and either the Ratio Setpoint is set to zero, or Inhibit Input is active, or the main flow stays at zero longer then preprogrammed delay.

Local Mode

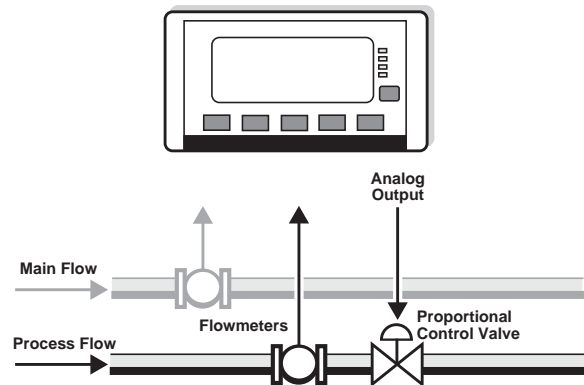

The desired process control output (P-CTRL %) is manually set via the front panel or serial communications.

The output signal is used to drive the proportional control valve to the desired position.

The control of the process line is independent of the main flow.

The main flow input can be used and measured but is not necessary.

Loop Mode

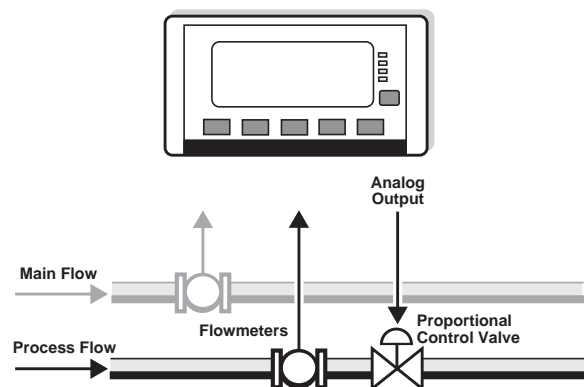

The desired process flowrate set point (P-FLOW SP) is set via the front panel or serial communications.

The PI controlled output signal is used to maintain the desired process flowrate via the proportional control valve.

The control of the process line is independent of the main flow.

The main flow input can be used and measured but is not necessary.

Tune Mode - CAL MODE ONLY

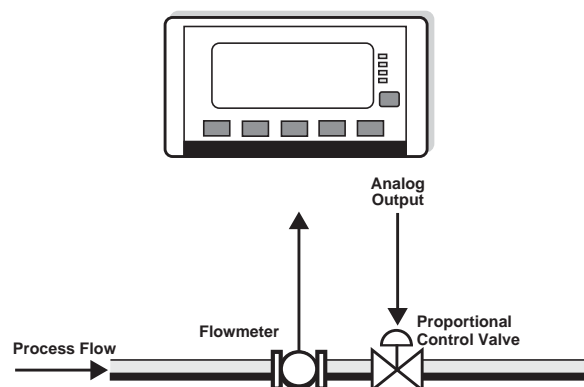

This mode is only accessed from within calibration mode and allows the operator to view a concise list of key parameters and gain immediate feedback. The Proportional Band (P-BAND) and Integral Time (I-TIME) are entered to tune the system.

For details on this method see below: **”Tuning the Control Loop”**.

The control and tuning of the process line in this mode is independent of the main flow.

Ratio Mode

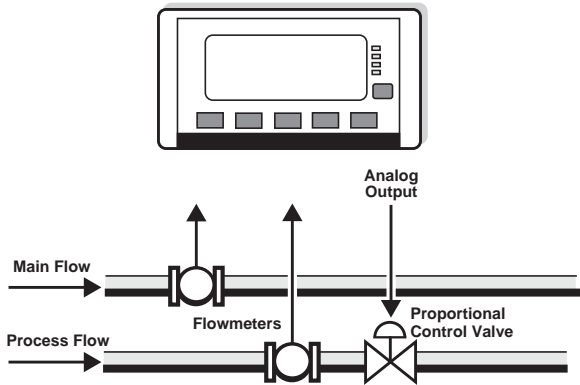

The desired process ratio set point (RATIO %) is set via the front panel or serial communications.

The PI controlled output signal is used to maintain the desired process flowrate via the proportional control valve.

The desired process flow is determined as a ratio of the main flow (0 to 400% range) i.e.

$$Ratio\% = \frac{P_{flow}}{M_{flow}} \times 100$$

Blend-1 Mode

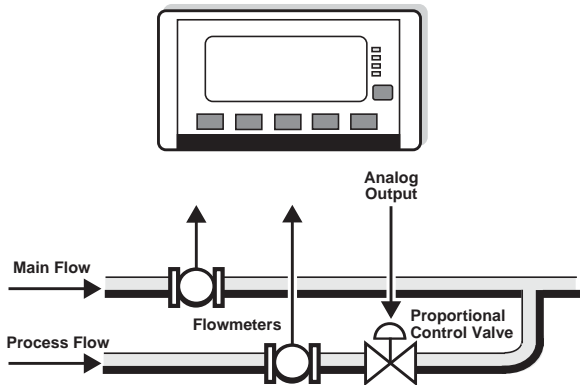

The desired blending ratio set point (RATIO %) is set via the front panel or serial communications.

The PI controlled output signal is used to maintain the desired process flowrate via the proportional control valve.

The desired process flow is determined as a ratio of the net (combined) flow (0 to 80% range). i.e.

$$Ratio\% = \frac{P_{flow}}{M_{flow} + P_{flow}} \times 100$$

Blend-2 Mode

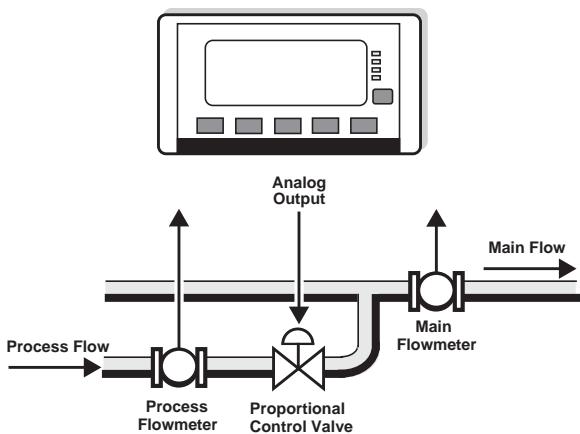

The desired blending ratio set point (RATIO %) is set via the front panel or serial communications.

The PI controlled output signal is used to maintain the desired process flowrate via the proportional control valve.

The desired process flow is determined as a ratio of the main (net) flow (0 to 80% range). i.e.

$$Ratio\% = \frac{P_{flow}}{M_{flow}} \times 100$$

Logic Input Control

Logic input 1 has the function of 'Inhibit Process Flow'. This feature allows the process flow to be disabled to assist in 'flushing' of the system or for deliveries of the main product to be made without the process product being added. For connection details, refer to **Logic Input Connection** on page 12.

The active level of the inhibit signal is determined by the 'Loop Inhibit Active Signal' parameter, which can be set to be either an OPEN or CLOSED circuit. This input will inhibit the process flow while the signal is in the active state by forcing the process control output to drive to zero. The 'Run' led on the front panel will flash when this feature is active. Even while the inhibit input is active, any flow detected on either the main or process flow inputs will be counted.

Tuning the Control Loop

The Process Controller has a special control mode within the Parameters section of calibration to assist in tuning the control loop. This mode provides a concise list of key parameters and allows for immediate feedback. The basic principle in tuning the loop is to gradually adjust the Proportional Band (P-BAND) and the Integral Time (I-TIME) and observe the response to a step change in the setpoint.

The tune menu provides for this by allowing the P-BAND and I-TIME to be programmed and then a Process Flow (P-FLOW) setpoint value can be entered. The next items in the menu are the actual live process variable and the deviation from the target value, so that the response of the system to a setpoint change can be observed. Unless the menu is quit the program will step back to start of the tuning menu so that new values of P-BAND and I-TIME can be entered and the effect of a step change in the setpoint be monitored.

This sequence is followed for all modes where the flow in the process line is controlled. The tuning procedure is as follows:

1. Before tuning the control loop it is essential to program in the correct parameters for the flowmeters, including filtering.
2. The actual Process Flow Range (P-FLOW RANGE) should be measured (or estimated) and entered. It can be determined in Local mode by setting the output to 100% (20mA) and observing the steady state flowrate.
3. With the Loop Error Deadband (D-BAND) and the Output Ramp Time (R-TIME) set at zero, the I-TIME should be set to zero (disabled) and the P-BAND set at 150%.

Gradually decrease the P-BAND value until the system begins to oscillate when a small step change of the setpoint is introduced. When this occurs, double the value of the P-BAND.

4. Next set the I-TIME to 20 seconds and gradually decrease the value until the system again begins to oscillate when a small step change of the setpoint is introduced. When this occurs double the value of the I-TIME.
5. The Ratio Trim Time can now be tuned if required (see below: **Tuning the Ratio Trim Control**) or the Deadband and the Output Ramp Time can now be programmed as required.

The system should be tuned around the flowrate at which the eventual system will operate. The stability of the loop should then be checked at various flowrates and setpoints.

Tuning the Ratio Trim Control

The ratio trim control is a unique feature that can be used when it is critical for the totals to maintain the correct ratio. If enabled (non-zero), the trim control will modify the process flow to achieve the correct ratio between the totals.

The trim time feature is implemented as a cascade control, a combination of two controllers, where the output signal from one controller forms the setpoint of the other. Cascade control is used when there are two or more available measurements (flowrate and total), but only one manipulated variable (the process flowrate).

Trim control only applies to the Ratio and Blend control modes. The Trim Time (T-TIME) is entered as a part of the parameters menu in calibration when either of these modes are selected. At the end of these menus there is the RATIO setpoint, the actual live process variable and the deviation from the target value, so that the response of the system to a setpoint change can be observed. Unless the menu is quit the program will step back to start of the menu so that a new T-TIME value can be entered and the effect of a step change in the setpoint be monitored.

The trim time for a system is somewhat arbitrary. The actual value to be used for the trim time is very much dependent on the operator's desired behaviour of the system. A short T-TIME will mean that the totals will reach the desired ratio in a shorter time in response to a step change in setpoint. However the faster the response the greater likelihood of flowrate overshoot.

Alternatively a long T-TIME will have much less risk of flowrate overshoot but it would require a longer time for the totals to reach the desired ratio in response to a step change in setpoint.

The trimming is not based on the actual values of the totals but on additional registers which count in unison with the displayed totals. These additional internal registers are reset whenever:

- the Control Mode is changed,
- the Ratio Setpoint is changed,
- the Totals are cleared.
- the flow control exception is raised.

Follow this sequence for tuning the trim time for the ratio and blend control modes if trim control is required:

- 1.** Before tuning the trim control it is essential that the control loop has been tuned first.
- 2.** With the Loop Error Deadband (D-BAND) and the Output Ramp Time (R-TIME) set at zero the T-TIME should be initially entered as 4 times the Integral Time.

Introduce a step change in the setpoint and observe the response of the system.

- 3.** Increase or decrease the T-TIME to achieve the desired response.
- 4.** The Deadband and the Output Ramp Time can now be programmed as required.

The stability of the loop should be again checked at a few different working flowrates and ratios.

Chapter 5

Instrument Calibration

Introduction

You can view or change the settings of the instrument according to the access level for each parameter as set by the manufacturer. There are four levels of access to the parameters as follows:

- **Not visible** - you cannot display or edit the parameter.
- **Display Only** - you can display the parameter, but you cannot change the setting.
- **Programmable** - you can change the setting of the parameter in Calibration Set mode.
- **Password protected** - you can change the setting of the parameter in Calibration Set mode only if you enter the correct password.

Note: When you enter Calibration Set mode, the instrument requests you to enter a password. Any value will allow to change the settings of the “programmable” parameters, but the correct password must be entered to change the password-protected parameters.

Calibration View Mode

Use the following procedure to view the calibration settings of the instrument:

1. Press **DISPLAY** to scroll to the **CFM MENU** prompt.
2. Hold the **SET** key.



The instrument beeps once, illuminates the **Cal** indicator and shows **CFM** on the display panel.

- Press **▶** to scroll through the flashing menu headings.
 - Press **SET** to scroll through submenu items.
 - Press **DISPLAY** to return to the main calibration menu.
3. To exit from the Calibration View mode, press **▶** to scroll to the **END** option and press **SET**.

The instrument returns to Normal Operation mode.

Calibration Set Mode

In Calibration Set mode, you can change the settings of the “programmable” parameters. You must enter the system password to change the setting of the “password-protected” parameters.

Use the following procedure to enter Calibration Set mode:

1. Press **DISPLAY** to scroll to the **FL MENU** prompt.
2. Hold the **SET** key.



The instrument beeps once, illuminates the **Cal** indicator and shows **FL** on the display panel.

3. Press **▶** to select any flashing menu heading except **END**.
4. Hold **SET** for two seconds.

The instrument requests a password.

5. Press **▲** or **▼** to change the value of the current digit. To select the next digit, press **▶**.
6. Press **SET** to accept the password.
 - The instrument makes two beeps for a correct password entry and enables you to change the “programmable” and “password-protected” parameters.
 - The instrument makes one beep for an incorrect password entry and enables you to change only the “programmable” parameters.



The instrument illuminates both the **Cal** and **Set** indicators.

7. Edit the instrument parameters as required. The programmable values are indicated by the flashing display.
 - To change a numerical value, press **▲** to increase a value, or press **▼** to decrease a value. Press a key momentarily to change the value one number at a time. Hold a key to scroll through the numbers. To proceed to next digit, press **▶**.
 - To change an option setting, press **▲** or **▼** to scroll through the options.
8. Press **SET** to accept the currently displayed value and proceed to the next parameter. You can press **DISPLAY** to return to the main calibration menu.
9. To exit from Calibrate Set mode, press **▶** to scroll through the main calibration menu to **END**, then press **SET**. Otherwise, from any menu, you can press and hold **SET** for two seconds.



The instrument makes two beeps and cancels the **Cal** and **Set** indicators.

Changing the Instrument Settings

In Calibration Set mode, the display flashes the item that can be changed. For option settings, the display flashes the complete option. For a numeric parameter, the display flashes one digit at a time, you can change the value of the flashing digit as required, then move the flashing cursor to change another digit.

Note: When you change the setting of a parameter, the instrument records the result as soon as you move to another parameter, or exit from the Calibration Set mode.

Changing Option Settings

When you display an option that can be changed, the entire option flashes on the display, such as the choices of ODD, EVEN or NONE for the communications parity bit checking. Press or to change the option. You can “scroll” through the options in either direction to make a selection as shown below.

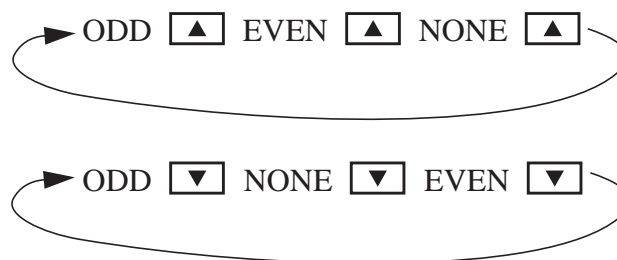

Changing Numeric Settings

The display flashes the digit that can be changed.



Press to select the digit that you wish to change.

Press or to increase or decrease the value of the selected digit.

Changing the Decimal Point

To change the position of the decimal point, press to move the flashing selection until the decimal point flashes. Press or to move the decimal point to the right or left as required.

Units of Measurement

The calibration of some parameters is based on the units that are defined for the relevant variables. These units of measurement can be viewed in the UNITS menu in calibration below.

Calibration Menu Tree

Figure 14 and Figure 15 show the keys for moving around the calibration menu tree in Calibration View or Set mode.

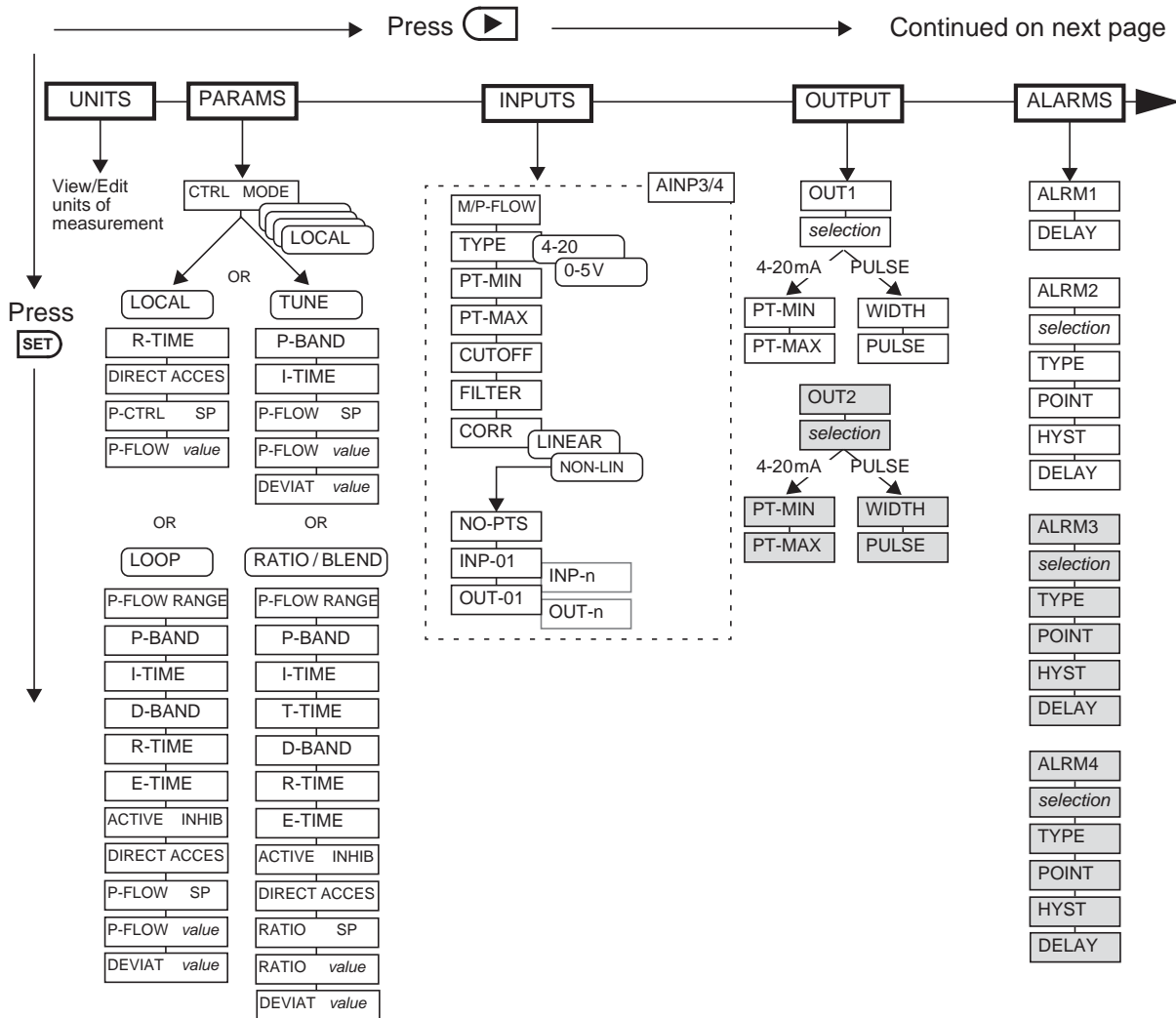

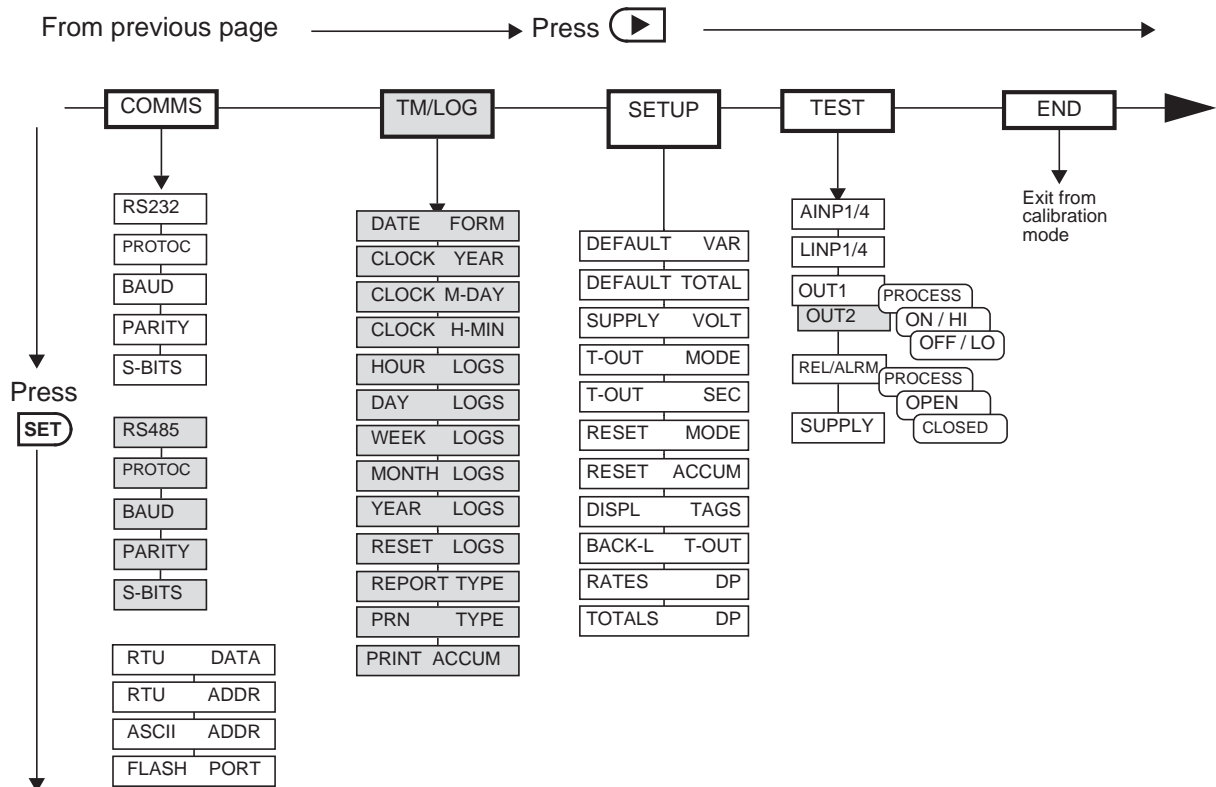

 The shaded boxes indicate hardware options

Press  at any point to return to the main calibration menu.



Press  at any I/O assignment position to move to the next I/O assignment in the submenu (eg pressing  on ALRM1 will move you to ALRM2 if it exists)

Figure 15 Calibration Menu Tree Sheet 2





Instrument Settings







Units of Measurement

The Units menu allows the units to be viewed and edited if necessary without the reloading of new application software. Any change in units will result in a full reset to initially downloaded settings. Therefore, any required changes to units of measurement should be made before changing any other settings.

| | |
|---------------------------------------|--|
| <p>SET ↓</p> | <p>▶ → UNITS PARAMS INPUTS OUTPUTS ALARMS COMMS TM/LOG SETUP TEST END</p> |
| <p>ITEM <i>n</i> <i>unit</i></p> | <p>The units for main menu or calibration items can be viewed by pressing the SET key.</p> <p>The units of measurement are password protected. To edit the units the correct password must be entered on entry to EDIT mode.</p> <p>Press ▲ or ▼ to select the required units. Refer to Available Units of Measurement on page 80 for the list of available units.</p> |
| <p>ACCEPT UNITS</p> | <p>The Accept Units prompt will only appear if one or more of the units have been changed.</p> <p>IMPORTANT: Accepting the change of units will initiate a master reset. All calibration parameters will revert to their default value (i.e. those values included in the downloaded instrument software). All totals and any logged information will be cleared.</p> <p>Press ▲ or ▼ to select YES, then press the SET key. The instrument makes three beeps to confirm the reset command.</p> <p>The message -RESET- PLEASE WAIT will be displayed as the instrument exits calibration mode and completes a full re-boot sequence.</p> |

Parameters

| | |
|---|---|
|  ↓ |  → UNITS PARAMS INPUTS OUTPUTS ALARMS COMMS TM/LOG SETUP TEST END |
| CTRL MODE | <p>Select the required loop control mode.</p> <p>Press  or  to select either: LOCAL, LOOP, TUNE, RATIO, BLEND-1 or BLEND-2.</p> <p>Refer to Process Control Modes on page 24 for descriptions of each mode.</p> |
| <p>Note: The items actually shown under the PARAMS menu are dependent on the CONTROL MODE chosen above. Items that are not relevant for that mode will not appear.</p> | |
| P-FLOW RANGE | <p>The process or loop flow range is the maximum flowrate that the system will achieve on the process flow line. This value is used by the loop control algorithm and is entered in the same units as the main menu Process Flowrate variable. It can be determined by setting the process control setpoint to 100% whilst in LOCAL mode and observing the flowrate.</p> |
| P-BAND % | <p>The proportional band of PI control algorithm.</p> <p>Enter the value in percentage. For means of determining this value see Tuning the Control Loop on page 27.</p> |
| I-TIME SEC | <p>The loop integral time of PI control algorithm. This parameter should be programmed as a non-zero value to enable the integral term in the control algorithm.</p> <p>Enter the value in seconds. For means of determining this value see Tuning the Control Loop on page 27.</p> |
| T-TIME SEC | <p>The loop ratio trim time. The integral time of cascade trim control can be used when it is critical for the totals to maintain the correct ratio. If enabled (non-zero), the trim control will modify the process flow to achieve the correct ratio between the totals.</p> <p>Enter the value in seconds. For means of determining this value see Tuning the Ratio Trim Control on page 28.</p> |
| D-BAND % | <p>The loop error deadband can be programmed to prevent the output continuously changing and thereby reducing wear on valves and actuators. Enter the value as a percentage of the Flow Range parameter.</p> <p>While the main menu Deviation (error) is within the deadband, the process control signal will remain steady (i.e. the error is treated as zero in the algorithm).</p> |

|  ↓ | |  → UNITS PARAMS INPUTS OUTPUTS ALARMS COMMS TM/LOG SETUP TEST END |
|---|--------|---|
| R--TIME | SEC | The ramp time limits the rate of change of the loop output signal and assists in bumpless loop operation when changing operation mode or loop parameters. It represents the minimum time required for the output signal to traverse between saturation points (i.e. from 0 to 100% or vice versa). |
| E--TIME | SEC | The loop control error time allows an exception to be raised when the loop output stays in saturated condition longer than the programmed error time (i.e. the loop cannot be controlled). To disable this exception set the loop control error time to zero. |
| ACTIVE | INHIB | The loop inhibit active signal parameter determines whether an open or closed circuit, on logic input 1, inhibits the process flow. Press  or  to select OPEN or CLOSED. |
| DIRECT | ACCESS | If the direct access is enabled then the operator is able to enter edit mode for the controlling setpoint directly from the main menu by holding the  key while viewing the setpoint. If disabled the setpoint can only be changed from within calibration set mode (or via serial communications, see below). Select the direct access mode as required. Press  or  to select ENABLE or DISABLE. |
| Modbus Accessible Parameters | | |
| The following PARAMS menu item is also accessible via Modbus communications. For Modbus register listing, refer to Instrument Configuration Parameters on page 68. | | |
| P--CTRL | SP | Loop/Process control signal setpoint. This setpoint is only available for LOCAL control mode. |
| If LOCAL control mode the live P-FLOW value is now shown to give immediate feedback without leaving calibration set mode. | | |
| P--FLOW | SP | Loop/Process flowrate setpoint. This setpoint is only available for LOOP control and TUNE modes. The value of the setpoint must not be greater than the process flow range (P-FLOW RANGE). |
| If LOOP control or TUNE mode the live P-FLOW and DEVIATION values are now shown to give immediate feedback without leaving calibration set mode. | | |
| RATIO | SP | Loop ratio setpoint. This setpoint is only available for RATIO and BLEND control modes. For ratio mode the allowable range is 0 to 399.999%. For blend mode the value must be within the range 0 to 80%. |
| If RATIO or BLEND control mode the live RATIO and DEVIATION values are now shown to give immediate feedback without leaving calibration set mode. | | |

Inputs







| SET ↓ | ▶ → UNITS PARAMS INPUTS OUTPUTS ALARMS COMMS TM/LOG SETUP TEST END |
|--|--|
| Analog Input 3 & 4 | |
| INPUT M-FLOW AINP3 P-FLOW AINP4 | Analog Input Channels 3 and 4 are assigned as volumetric flowrate inputs. Channel 3 is used for measuring the main line flow and channel 2 is used for the process line flow. |
| TYPE AINP3 AINP4 | Select the type of analog input source. Press <input type="button" value="▲"/> or <input type="button" value="▼"/> to select 0-5V, 1-5V or 4-20mA. |
| PT-MIN AINP3 PT-MAX AINP4 | Enter the value of the measured parameter (in the defined engineering units) that corresponds to the minimum input signal level. The minimum point is commonly set at a base flowrate of 0.0. Enter the value of the measured parameter (in the defined engineering units) that corresponds to the maximum input signal level. The maximum point is the same as the base value (set at the minimum point) plus the span value. For example, if the source signal is 4mA at a minimum volumetric flowrate of 2m ³ /M, enter 2 as the minimum point. If the source signal is 20mA at a maximum volumetric flowrate of 250m ³ /M, enter 250 as the maximum point. |
| CUTOFF AINP3 AINP4 | The Cut-off is the lowest value that the instrument reads from the input sensor. The cut-off setting is the percentage of the span of the input values. All inputs at or below the cut-off value are considered negligible to the instrument and are ignored. In this case, the instrument uses the minimum value (set at PT-MIN). |
| FILTER AINP3 AINP4 | Input fluctuations caused by pulsating flow tend to create distortion in the input readings of the rate. The instrument has a digital filter that averages out these fluctuations. As a guide to the degree of filtering to use, the following table shows the response time (in seconds) to reach 90% and 99% of a step change in input. The value A is the filter constant that the user can set. |

| <input type="button" value="SET"/> ↓ | | <input type="button" value="▶"/> → UNITS PARAMS INPUTS OUTPUTS ALARMS COMMS TM/LOG SETUP TEST END | |
|--------------------------------------|---|--|------------------------------------|
| | Filter setting A | Seconds to reach 90% of full swing | Seconds to reach 99% of full swing |
| | 0 | 0 | 0 |
| | 2 | 2 | 4 |
| | 4 | 4 | 8 |
| | 6 | 5 | 10 |
| | 10 | 8 | 15 |
| | 15 | 12 | 23 |
| | 20 | 14 | 27 |
| | 25 | 18 | 34 |
| | 35 | 25 | 48 |
| | 45 | 32 | 62 |
| | 60 | 42 | 82 |
| | 75 | 52 | 102 |
| | 90 | 62 | 122 |
| | 99 | 68 | 134 |
| | The input filter range is from 0 to 99. A setting of 0 (zero) means that there is no filtering. | | |
| CORR | RINP3 RINP4 | Analog input non-linearity can be corrected as follows: <ul style="list-style-type: none"> • LINEAR • NON-LINEAR to use the following linearity correction parameters Use <input type="button" value="▲"/> or <input type="button" value="▼"/> to select LINEAR or NON-LINEAR. | |
| NO-PTS | RINP3 RINP4 | <i>This parameter is available for viewing and editing only when the correction type is set to Non-linear.</i> <p>Enter the number of non-linearity correction points.</p> Press <input type="button" value="▲"/> or <input type="button" value="▼"/> to select a number between 1 and 20 for the number of correction points. | |

| | |
|-----------------------------------|--|
| SET ↓ | → UNITS PARAMS INPUTS OUTPUTS ALARMS COMMS TM/LOG SETUP TEST END |
| INP-01 RINP3 to RINP4 INP-n | <p><i>This parameter is available for viewing and editing only when the correction type is set to Non-linear.</i></p> <p>Enter the normalised input value for the correction point.</p> <p>The instrument uses linear interpolation between the correction points. An input and an output value are entered for each correction point. The values are normalised between the minimum point (0.0) and the maximum point (1.0). Only the points between 0 and 1 are required to be entered and should be entered in ascending order.</p> <p>The following diagram shows a 5 point linearised representation of the input for a hypothetical flowmeter. The heavy black line represents the actual input from the flowmeter. The light black line is the approximation that the instrument uses.</p> <p>You can press the DISPLAY key to skip the non-linear points and go to the next item.</p> |
| OUT-01 RINP3 to RINP4 OUT-n | <p><i>This parameter is available for viewing and editing only when the correction type is set to Non-linear.</i></p> <p>Enter the normalised output value for the correction point.</p> |

Outputs

| | |
|--|---|
| SET ↓ | → UNITS PARAMS INPUTS OUTPUTS ALARMS COMMS TM/LOG SETUP TEST END |
| <p>Note: In the factory default version of this application output channel 1 (OUT1) is dedicated as the 4-20mA Process Control signal. Output channel 2 can be freely configured.</p> | |

|  ↓ |  → UNITS PARAMS INPUTS OUTPUTS ALARMS COMMS TM/LOG SETUP TEST END |
|---|---|
| PULSE or 4-20 | <p data-bbox="427 304 1350 409"> You can assign any of the “main menu” variables to an output. The nature of the output depends on the assigned variable. Totals are output as pulses and rates are output as 4-20mA passive signals. </p> <p data-bbox="427 450 1350 555"> Press  or  to select the variable that is required as an output. The top of the display shows the type of output signal that is assigned to the variable. </p> <p data-bbox="831 595 983 629" style="text-align: center;">CAUTION</p> <p data-bbox="501 636 1275 741" style="text-align: center;"> Due to the dual-purpose nature of the outputs, take care not to set the output as an open collector pulse type signal when connected to a 4-20mA loop circuit. </p> |
| WIDTH | <p data-bbox="427 775 1350 846"> <i>The Output Pulse Width is available for viewing and editing only when the assigned variable is a total (pulse output) type.</i> </p> <p data-bbox="427 887 1350 958"> Pulse output is usually used to drive remote counters. Set the pulse width (in milliseconds) as required by the remote counter. </p> <p data-bbox="427 999 1185 1028"> Press  or  to set to: 10, 20, 50, 100, 200 or 500ms. </p> |
| PULSE | <p data-bbox="427 1066 1350 1137"> <i>The Output Pulse Factor is available for viewing and editing only when the assigned variable is a total (pulse output) type.</i> </p> <p data-bbox="427 1178 1350 1249"> The Output Pulse Factor is the scaling factor for the retransmission of the measured total quantity. </p> <p data-bbox="427 1290 1350 1395"> For example, if “volume” is chosen as an output variable and engineering unit is cubic metres, then a pulse factor of 1.000 generates one pulse for 1 m³. Similarly, a pulse factor of 3.000 generates one pulse for 3 m³. </p> <p data-bbox="427 1435 1206 1464"> For more information, see Output Pulse Factor on page 43. </p> <p data-bbox="427 1505 975 1534"> The output pulse factor cannot be 0 (zero). </p> |

| SET ↓ | ▶ → UNITS PARAMS INPUTS OUTPUTS ALARMS COMMS TM/LOG SETUP TEST END |
|------------------------------------|--|
| PT--MIN OUTn PT--MAX OUTn | <p><i>The Output Minimum Point and Maximum Point are available for viewing and editing only when the assigned variable is a rate (4-20mA output) type.</i></p> <p>The output minimum value corresponds to the 4mA point and the output maximum value corresponds to the 20mA point.</p> <p>Setting the output range differently from the input range enables the instrument to amplify the input signal. You can drive a chart recorder that “zooms in” on a specified range of values instead of displaying the full operating range of the transducer.</p> <p>For example, if “volume flow” is chosen as an output variable and engineering unit is cubic metres per minute, then setting the minimum point to 30 and the maximum point to 100 would reflect the volumetric flow rate range of 30 to 100m³/min. At rates above the maximum and below the minimum points, the output remains at 20mA and 4mA respectively.</p> |

Output Pulse Factor

Increasing the output pulse width reduces the maximum frequency at which a total variable can be retransmitted. Pulses will be missed if the output cannot “keep up” with the rate of total counts. You can use the output pulse factor to ensure that this maximum is not reached.

The maximum pulse output frequency is determined by:

$$\frac{1000}{(2 \times \text{pulse width in ms})} \text{ Hz}$$

The minimum pulse factor required is determined by:

$$\frac{\text{max rate of total}}{\text{max pulse output frequency}}$$

For example: To calculate the required pulse factor to avoid losing counts in retransmission if a total counts at a maximum rate of 75 units/sec (Hz) and the required pulse width of a remote counter is at least 50ms:

$$\text{The maximum pulse output frequency is: } \frac{1000}{2 \times 50} = 10 \text{ Hz}$$

$$\text{The minimum pulse factor for that frequency is: } \frac{75}{10} = 7.5$$

Alarms



The alarm relay(s) can be assigned to rate variables such as flow rate, or set as an equipment failure alarm.

The alarm switches “on” whenever an alarm condition exists. The alarm switches “off” when the alarm condition no longer exists. However, you may need to configure external alarm devices that require acknowledgement for cancelling an alarm.

Equipment Failure Alarm

Any alarm relay can be assigned as an equipment failure alarm. This alarm setting can have normally closed (open) contacts that open (close) when the instrument displays any error message as listed in [Error Messages](#) on page 53.

| SET ↓ | | ▶ → UNITS PARAMS INPUTS OUTPUTS ALARMS COMMS TM/LOG SETUP TEST END |
|---|-------------------|---|
| RELAY | ALRM _n | <p>Select a rate variable to assign to the alarm relay.</p> <p>Note: If the alarm type is set to “equipment alarm”, this relay assignment setting is ignored.</p> <p>Press ▲ or ▼ to select the variable that is required as an alarm.</p> |
| TYPE | ALRM _n | <p>The options available for alarm types are as follows:</p> <ul style="list-style-type: none"> • HI-NO - High Alarm, contacts are Normally Open • HI-NC - High Alarm, contacts are Normally Closed • LO-NO - Low Alarm, contacts are Normally Open • LO-NC - Low Alarm, contacts are Normally Closed • BD-NO - Band Alarm, contacts are Normally Open • BD-NC - Band Alarm, contacts are Normally Closed • AL-NO - Equipment Alarm, contacts are Normally Open • AL-NC - Equipment Alarm, contacts are Normally Closed <p>Press ▲ or ▼ to select the type of alarm required.</p> |
| POINT | ALRM _n | <p><i>The Alarm Setpoint is available for viewing and editing for any alarm type except ‘equipment alarms’.</i></p> <p>The Alarm Setpoint is the value (in engineering units of assigned variable) at which the alarm condition occurs and therefore the alarm is on.</p> <p>Each alarm is completely independent, e.g. a High alarm does NOT need to have a higher setpoint than the a Low alarm.</p> |

|  ↓ | |  → UNITS PARAMS INPUTS OUTPUTS ALARMS COMMS TM/LOG SETUP TEST END |
|---|-------------------|--|
| HYST | ALRM _n | <p><i>The Alarm Hysteresis is available for viewing and editing for any alarm type except 'equipment alarms'.</i></p> <p>Alarm hysteresis loops occur when the alarm toggles continuously on and off when the process variable is close to the setpoint.</p> <p>For a high alarm, the alarm activates when the value of the variable rises above the alarm setpoint and deactivates when the value falls below the alarm setpoint minus the amount of the hysteresis setting (if any).</p> <p>For a low alarm, the alarm activates when the value of the variable falls below the alarm setpoint and deactivates when the value rises above the alarm setpoint plus the amount of the hysteresis setting (if any).</p> <p>For a band alarm, the alarm activates whenever the value of the variable is outside the setpoint plus or minus the amount of the hysteresis.</p> <p>For example, with a high alarm setpoint of 200, and a hysteresis setting of zero, a value oscillating between 197 and 202 will cause the alarm to toggle on at 200 and toggle off below 200. However, if the hysteresis is set to 5, the value of the variable must fall below 195 to cancel the alarm. The alarm will reactivate only when the value again rises above 200.</p> |
| DELAY | ALRM _n | <p>The Alarm Delay is programmed in seconds and can be used to eliminate undesired alarm activation during start-up or shutdown operation.</p> |

Communications

The instrument has the following communication ports:

- **RS-232 Port** - A 9-pin female connector on the rear panel of the instrument.
- **RS-485 Port** (optional) - Terminals on the rear panel.
- **Infra-red Port** - Discontinued - Although program settings may be visible in calibration, the required hardware is no longer available. The Infra-red protocol assignment (PROTocol INFRa) should be set to NONE and the remaining INFRa settings can be ignored.

| SET ↓ | | ▶ → UNITS PARAMS INPUTS OUTPUTS ALARMS COMMS TM/LOG SETUP TEST END |
|-------------------------------------|---|---|
| PROTOC RS232 RS485 INFRA | <p>The Communications Protocols can be assigned to the communication ports as follows (a protocol cannot be assigned to more than one port at a time):</p> <ul style="list-style-type: none"> • ASCII - Simple ASCII available for all ports • RTU - Modbus RTU available for all ports • PRN - Printer Protocol available for RS232 and RS485 • NONE - If a port is not being used, set the protocol to NONE. <p>Printer Protocol (PRN) is only available if the option with Real Time Clock is installed.</p> <p>For the selected port, press ▲ or ▼ to select the desired protocol.</p> | |
| BAUD RS232 RS485 INFRA | <p>The Baud setting is the speed of the communication port in data bits per second.</p> <p>The baud rate of the instrument must match the baud rate of the communication device that the instrument is connected to.</p> <p>Use ▲ or ▼ to select 2400, 4800, 9600 or 19200 baud.</p> | |
| PARITY RS232 RS485 INFRA | <p>The Parity bit helps to detect data corruption that might occur during transmission.</p> <p>The parity bit setting of the instrument must match the parity bit setting of the communication device that the instrument is connected to.</p> <p>Press ▲ or ▼ to select EVEN, ODD, or NONE.</p> | |
| S-BITS RS232 RS485 INFRA | <p>The Stop bit indicates the end of a transmission. Stop bits can be 1 or 2 bit periods in length. The stop bit setting of the instrument must match the stop bit setting of the communication device that the instrument is connected to.</p> <p>Press ▲ or ▼ to select 1 or 2 stop bits.</p> | |
| RTU DATA | <p>The Modbus RTU data format for the 2-register (4-byte) values can be set as either floating point or long integer values.</p> <p>Use ▲ or ▼ to select FLOAT or INTEGER.</p> | |

| SET ↓ | ▶ → UNITS PARAMS INPUTS OUTPUTS ALARMS COMMS TM/LOG SETUP TEST END |
|---------------|--|
| RTU ADDR | <p>The Modbus RTU protocol address must be in the range of 1 to 247. When multiple instruments (slaves) are connected to one communication device (master), each assigned address must be unique.</p> <p>Note: The master device uses the RTU address 0 (zero) for broadcasting to all connected slave units.</p> |
| ASCII ADDR | <p>The ASCII protocol address identifies each communicating device.</p> <p>The address must be in the range of 1 to 255. When multiple instruments (slaves) are connected to one computer (master), each assigned address must be unique.</p> |
| FLASH PORT | <p>The Flash Driver Port assignment defines the communication port for downloading software into the instrument.</p> <p>The default setting of this assignment is the RS-232 port.</p> <p>Press ▲ or ▼ to select RS-232, RS-485, or INFRA.</p> |

Time Settings and Data Logging

Instrument Clock

Note: The real-time clock is part of the advanced option package.

The instrument has a real-time clock for recording logged events. The clock displays the time and the date. The date format can be set to European format (day/month/year) or American format (month/day/year). The time clock uses the 24-hour format.

The clock will continue to operate for up to 5 years (typically) on the internal battery if there is no power connected to the instrument. Therefore, after an interruption to the power supply, the instrument recommences normal operation although there will be no data recorded during the period without a power supply.

Note: If there is an interruption to the power supply and the battery has failed, the instrument displays an error message when the power supply is restored. In this case, you should set the current time and date so that the instrument continues to log data at the correct times.

Data Logging

The instrument can store over 1000 log entries of the main-menu variables. There are 800 hourly, 400 daily, 200 weekly, 100 monthly and 30 yearly logs. The log parameters (below) for each timebase are used to determine the number of records to be included in a report print out if the printing option is used.

| SET ↓ | | ▶ → UNITS PARAMS INPUTS OUTPUTS ALARMS COMMS TM/LOG SETUP TEST END |
|--------------|-------|---|
| DATE | FORM | <p>Clock Date Format</p> <p>The European date format is: dd/mm/yyyy or (Day-Month).</p> <p>The American date format is: mm/dd/yyyy or (Month-Day).</p> <p>Press ▲ or ▼ to select DAY-M or M-DAY</p> |
| CLOCK | YEAR | The Clock Year defines the current year for the real-time clock. |
| CLOCK | M-DAY | The Clock M-DAY setting defines the current month and date for the real-time clock. This parameter is programmed in Month-Day format for both European and American date formats. |
| CLOCK | H-MIN | The Clock H-MIN setting is the current time in hours and minutes for the real-time clock. |
| HOURLY | LOGS | <p>Set the number of Hourly Logs to appear on the printed log report.</p> <p>The hourly log entry occurs at 00 minutes each hour.</p> |
| DAILY | LOGS | <p>Set the number of Daily Logs to appear on the printed log report.</p> <p>The daily log entry occurs at 00 hours and 00 minutes each day.</p> |
| WEEKLY | LOGS | <p>Set the number of Weekly Logs to appear on the printed log report.</p> <p>The weekly log entry occurs at 00 hours and 00 minutes each Monday.</p> |
| MONTHLY | LOGS | <p>Set the number of Monthly Logs to appear on the printed log report.</p> <p>The monthly log entry occurs at 00 hours and 00 minutes on the first day of the month.</p> |
| YEARLY | LOGS | <p>Set the number of Yearly Logs to appear on the printed log report.</p> <p>The yearly log entry occurs at 00 hours and 00 minutes on the first day of the year.</p> |

| SET ↓ | ▶ → UNITS PARAMS INPUTS OUTPUTS ALARMS COMMS TM/LOG SETUP TEST END |
|--------------|---|
| RESET LOGS | <p>Reset the logged data. You may need to reset (clear) the logged data if you change the time/log settings.</p> <p>Press ▲ or ▼ to select YES, then press the SET key. The instrument makes three beeps to confirm the reset command.</p> |
| REPORT TYPE | <p>The Printer Protocol Report Type determines the nature of the printout from the REPORT PRINT - HOLD.SET prompt in the main menu. The following report types available in this instrument are:</p> <ul style="list-style-type: none"> • REP-01 Hourly Logs Report • REP-02 Daily Logs Report • REP-03 Weekly Logs Report • REP-04 Monthly Logs Report • REP-05 Yearly Logs Report • REP-06 Previous Day's 24 Hour Report (0Hr – 23Hr, minimum 48 hourly logs required) <p>Press ▲ or ▼ to select Report Type.</p> |
| PRN TYPE | <p>The Printer Protocol Printer Type allows the nature of the printer being used to be specified. The following printer types available in this instrument are:</p> <ul style="list-style-type: none"> • PRN-01 Generic computer printer • PRN-02 Generic roll printer (prints first line first) • PRN-03 Slip printer TM295 • PRN-04 Label (roll) printer - Citizen CMP30L <p>Press ▲ or ▼ to select Printer Type.</p> |
| PRINT ACCUM | <p>Select whether the accumulated totals are printed in addition to the non-accumulated totals for printer protocol.</p> |

General Setup Parameters

| SET ↓ | ▶ → UNITS PARAMS INPUTS OUTPUTS ALARMS COMMS TM/LOG SETUP TEST END |
|---------------|---|
| DEFAULT VAR | <p>Select the main menu variable to display on power up or when the display timeout period has elapsed if it is enabled.</p> <p>Press ▲ or ▼ to select the default variable display.</p> |
| DEFAULT TOTAL | <p>The instrument displays the default Total when the user presses the TOTAL key.</p> <p>Press ▲ or ▼ to select the default total display.</p> |
| SUPPLY VOLT | <p>The instrument provides a power-limited supply for external transducers.</p> <p>Press ▲ or ▼ to set the transducer supply voltage between 8 and 24 volts DC as required.</p> |
| T-OUT MODE | <p>If the Display Timeout mode is enabled, and there is no user activity for the defined timeout period, the display panel returns to the default display.</p> <p>This function is useful for the following reasons:</p> <ul style="list-style-type: none"> • to return the display to a preferred variable after the user has finished reading other information, • to cancel the calibration mode and return to the default display if the user does not exit from the calibration mode for any reason. <p>Press ▲ or ▼ to select the display timeout function as follows:</p> <ul style="list-style-type: none"> • DISABLE - Timeout is completely disabled. • EN DISP - Timeout is enabled during Normal mode and Calibration View mode. • EN EDIT - Timeout is enabled during Calibration Set mode. • EN ALL - Timeout is enabled for all modes. |
| T-OUT SEC | <p>The Display Timeout period defines the delay for the Display Timeout mode if it is enabled.</p> <p>The display timeout period can be from 10 to 99 seconds.</p> |

| <div style="border: 1px solid black; padding: 2px; display: inline-block;">SET</div> ↓ | <div style="border: 1px solid black; padding: 2px; display: inline-block;">▶</div> → UNITS PARAMS INPUTS OUTPUTS ALARMS COMMS TM/LOG SETUP TEST END |
|--|---|
| RESET MODE | <p>The Totals Reset mode can be configured to reset the non-accumulated totals to zero.</p> <p>Press <div style="border: 1px solid black; padding: 0 5px;">▲</div> or <div style="border: 1px solid black; padding: 0 5px;">▼</div> to select the reset mode as follows:</p> <ul style="list-style-type: none"> • NONE - The user cannot reset the non-accumulated totals. • INSTANT - When the user presses the RESET key, the instrument resets all non-accumulated totals. • DELAYED - When the user presses the RESET key and holds it for two seconds, the instrument resets all non-accumulated totals. |
| RESET ACCUM | <p>The Reset Accumulated Totals function clears all of the accumulated totals and the non-accumulated totals.</p> <p>Press <div style="border: 1px solid black; padding: 0 5px;">▲</div> or <div style="border: 1px solid black; padding: 0 5px;">▼</div> to select YES, then press the <div style="border: 1px solid black; padding: 2px; display: inline-block;">SET</div> key. The instrument makes three beeps to confirm the reset command.</p> |
| DISPL TAGS | <p>The Display Tags option determines whether the instrument displays the default display tags or the user-defined tags. The display tag setting also defines whether the instrument displays the default error and warning messages, or the user-defined messages.</p> <p>Note: The user-defined tags can be entered into the instrument only by the manufacturer or the distributor.</p> <p>Press <div style="border: 1px solid black; padding: 0 5px;">▲</div> or <div style="border: 1px solid black; padding: 0 5px;">▼</div> to select the Display Tags option as follows:</p> <ul style="list-style-type: none"> • DEFAULT - the instrument displays the default (English) tags • USER - the instrument displays the user-defined tags. |
| BACK-L T-OUT | <p>If the backlight timeout is enabled, and there is no user activity (any keys pressed) for a period of 10 seconds, the display backlight switches off to save power. The backlight switches on when a key is pressed. Select the backlight timeout mode as required.</p> <p>Press <div style="border: 1px solid black; padding: 0 5px;">▲</div> or <div style="border: 1px solid black; padding: 0 5px;">▼</div> to select ENABLE or DISABLE.</p> |
| RATES DP | <p>This parameter sets the maximum number of decimal places for displaying or printing main menu rates.</p> |
| TOTALS DP | <p>This parameter sets the maximum number of decimal places for displaying or printing main menu totals.</p> |

Test Menu

The Test menu enables you to view the inputs and outputs to and from the instrument.

In Calibration Set mode (by entering the system password), you can control the outputs and the alarms as described in the table below.

| [SET] ↓ | ▶ → UNITS PARAMS INPUTS OUTPUTS ALARMS COMMS TM/LOG SETUP TEST END |
|---|---|
| AINP _n Units | The units are displayed according to the calibration setup for the analog input. If unused or set to Default the input is 4-20mA and displayed in mA. |
| LINP _n STATE | You can view the state of the logic inputs. If the input is an open contact or inactive it will display HI . If the input is a closed contact or active it will display LO . |
| OUT _n STATE | <p>You can control the state of the outputs. Press the ▲ or ▼ keys to set the output state as follows:</p> <ul style="list-style-type: none"> • PROCESS - the output depends on the current values of the inputs and the calculations that the instrument performs. <p>For a pulse output, such as a total, the output produces a pulse train as follows:</p> <ul style="list-style-type: none"> • ON - a pulse train with a pulse width as set in the Outputs menu. • OFF - no output. <p>For a 4-20mA output, such as a rate, the output is as follows:</p> <ul style="list-style-type: none"> • HI - the output is set to 20mA. • LO - the output is set to 4mA. |
| ALRM _n STATE or REL -n | <p>You can control the state of the relays (alarms). Press the ▲ or ▼ keys to set the selected relay as follows:</p> <ul style="list-style-type: none"> • PROCESS - the relay operates according to the current values of the inputs and the relay settings as programmed. • OPEN - the relay output contacts are set to “open”. • CLOSED - the relay output contacts are set to “closed”. |
| SUPPLY ✓ | <p>You can display the actual DC output supply voltage, which may help with troubleshooting.</p> <p>If the actual supply voltage is lower than the preset value (refer to General Setup Parameters on page 50) it may indicate that the output is overloaded.</p> |

System Messages

The instrument displays messages for defined events and fault conditions.

The manufacturer or distributor can enter user-defined text for the messages. This user-defined text is displayed, instead of the default (English) messages, when the Display Tags option in the Setup menu is set to USER.

Error Messages

The instrument displays error messages as described in the following table:

| Error Messages | Description |
|-------------------------------|--|
| CPU Card Failure | There are failed components on the CPU card and technical support is required. |
| Power Supply is Low | The input and/or output power supply voltage is too low, ensure that: (a) input power supply voltage is within the specified range (b) output power supply is not overloaded. |
| New/Failed Battery - Set Time | The real-time clock has lost the correct time because the battery has failed, or there is a new battery. Set the current time and date (in the TM/LOG menu) to clear the error message and to continue data logging at the correct times. Note: The instrument can continue operating with a failed battery, but the correct time will be lost if there are interruptions to the power supply. |
| Main Flow Input Failure | The main line flowrate transmitter (analog input 3) has failed. |
| Process Flow Input Failure | The process line flowrate transmitter (analog input 4) has failed. |
| Loop Control Error | The loop control error is detected when the loop output stays in the saturated condition longer than the programmed loop control error time. To disable this exception set the loop control error time to zero. |

Warning Messages

The instrument displays warning messages as described in the following table:

| Warning Messages | Description |
|--------------------------------|--|
| Value Has Been Set to Default | You have entered an invalid value for a parameter. Therefore, the instrument has set the default value. |
| Over Total Limit - Maximum Set | You have exceeded the maximum number of logging entries for the combined time bases. The instrument has set the current log setting to the remaining maximum number. |

| Warning Messages | Description |
|--------------------------------|---|
| Already Assigned to Other Port | You have tried to assign a particular protocol type to more than one serial communication port. The instrument has set the protocol to NONE. |
| SP Over Limit - Maximum Set | <p>The control setpoint is greater than the allowed value. The instrument has set the value to the maximum limit.</p> <p>Either the process flow setpoint is greater than the flow range value or the ratio setpoint in blend mode is greater than 80%.</p> |

Chapter 6

Communications

Overview

This chapter describes the communications between the instrument and another communicating device such as a computer or a printer. You should have relevant information about the devices to which the instrument will be connected. Some connection examples are included in this manual, however, the operation and connection of other devices is outside the scope of this manual.

Hardware Interconnection

The instrument has two communication ports:

- RS-232 port on the rear panel (DB9 female connector)
- RS-485 port on the rear panel (optional)

The appropriate interface and protocols are selected during calibration.

RS-232 Port

The RS-232 port provides communication between the instrument and another device such as a host computer or a printer.

Note: A printer must have a serial port to be able to be directly connected to the flow computer. It is not possible to communicate directly with a printer via a parallel port.

Computers use either a DB9 or a DB25 connector, and the connections to each type are shown in Figure 16.

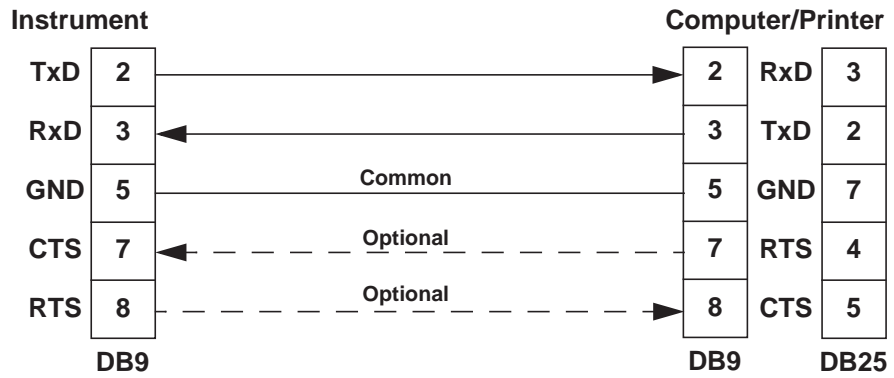

Figure 16 RS-232 Cable Connections to a Computer

Note: The instrument requires a cable with straight-through connections. Do not use a null modem cable for RS-232 connection to a computer.

RS-485 Port

The RS-485 port enables communication with multiple devices. Each device has a unique address so that the “master” device can communicate with specific “slave” devices.

On RS-485 links, an external terminating resistor must be connected at the furthest end of the cable. When multiple instruments are connected, they should be “daisy chained” in a multidrop configuration as shown in Figure 17. Up to 32 units can be connected to the interface at a maximum distance of 1200 metres.

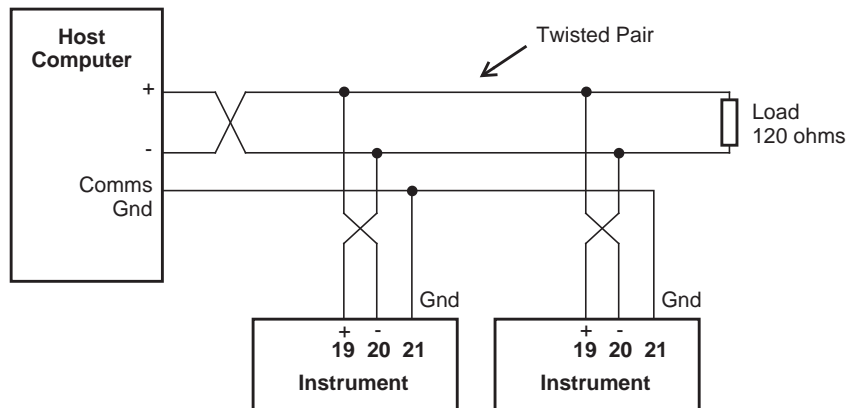

Figure 17 RS-485 Connections

Infra-red Port

The infra-red port is located on the front panel of the instrument. The infra-red port uses the Infra-red Developers Association (IrDA) physical layer format of signal encoding and decoding.

The nature of the infra-red port requires the communicating device to be located close to the front of the instrument. Therefore, its main use would probably be for reloading the instrument application software, or occasional collection of data, rather than continuous communications.

Protocols

The communications protocols can be assigned to the communication ports on the instrument as follows:

- **ASCII** - Simple ASCII available for all ports
- **RTU** - Modbus RTU available for all ports
- **PRN** - Printer Protocol available for RS232 and RS485
- **NONE** - If a port is not being used, set the protocol to NONE.

Note: The Printer Protocol is only available if the option with Real Time Clock is installed. Also a protocol cannot be assigned to more than one port at a time as described in **Communications** on page 45.

- **ASCII** - In this ASCII protocol each command and response is a string of ASCII characters. This proprietary protocol is developed by Contrec to allow for simple information interchange. The main advantages of this mode are that it allows extended time intervals to occur between characters without causing a timeout error and that messages can be sent and monitored easily with a simple ASCII terminal.
- **Modbus RTU** - Modbus RTU is an industry-standard protocol which allows the instrument to be easily connected to computers running supervisory software systems. The main advantage of this mode is that its greater character density allows better data throughput than ASCII mode, however each message must be transmitted in a continuous stream.
- **Printer** - In the Printer protocol there is a selection of printer types. Please refer to the **Printer Protocol** on page 69 for full details.

Simple ASCII Protocol

This simple ASCII protocol requires that all requests are initiated with a colon (:) and terminated with a carriage return (C_R). The message termination can include a linefeed before the carriage-return ($L_F C_R$), but it is the carriage-return that acts as the message termination.

All responses by the instrument are terminated with a linefeed and a carriage-return ($L_F C_R$).

Requests Format

The format of a request to the instrument is as follows:

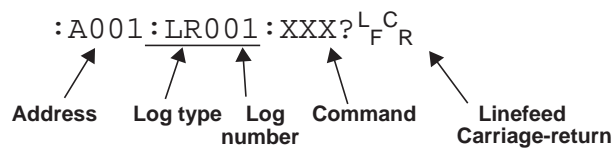

Each request must include the address and command portions. The underlined section is an optional part of the request string.

Address

In multipoint communications, each instrument must have a unique address and it is essential in the request for identifying a particular instrument. However, it may be set to 000, for special broadcast commands.

For single-instrument communications, the address can also be set to 000 in the request.

Refer to **Communications** on page 45 for setting the instrument address.

Note: The instrument always responds with its address in the header regardless of the type of request.

Log Type and Number

The log type and number enables a communicating device to retrieve data from the instrument. The data can be from timebased or event-based logs. Data can also be from the current process variables with either the accumulated or non-accumulated (resettable) totals. All logged records of the process variables contain the accumulated totals.

The log request is optional. If the log request is not included, or the log number is set to 000, the instrument returns the current process variables. If the log request is included, the log number defines the specific log entry by counting backwards. The most recent log entry for a timebase is 001.

The “last edit” log records the process variables at the time of the last exit from the calibration edit mode. There is only one “last edit” log, therefore, if a number is included in the request, the instrument ignores the number and returns the data at the time of the last edit. Likewise, there is only one set of current process variables with “non-accumulated totals”, therefore it also ignores any log number included in the request.

The types of logs applicable to this instrument are as follows:

| Log Type |
|--|
| LH - hourly log |
| LD - daily log |
| LW - weekly log |
| LM - monthly log |
| LY - yearly log |
| LE - last edit log |
| LN - current totals displayed as Non-accumulated |

The number of the log entry is the same as shown on the front panel of the instrument. For example, a request for LH003 would return the data for the log entry two hours prior to the most recent hourly log entry. If the current time is between 9:00am and 10:00am, the most recent hourly log LH001 was recorded at 9:00. Therefore, LH002 is for 8:00 and LH003 is for 7:00. After 10:00am in this example, LH003 becomes the 8:00 log.

Instrument Responses

The instrument response time to any enquiry is no more than 300ms. The responses from the instrument are in the following format:

```

HEADERLFCR
DATALFCR
DATALFCR
.
.
.
DATALFCR
LFCR
    
```

The components of the response message are as follows:

Header

The format of the response header from the instrument is as follows:

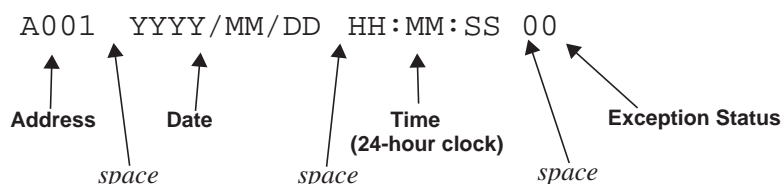

The instrument **Exception Status** codes that the instrument returns for the ASCII protocol are the same as those described for the Modbus RTU protocol in **Instrument Exception Status** on page 67.

Data

The format of the data variables from the instrument is as follows:

| | | | | | | | | | | | | | | | | | | | | | | | | | |
|-----------------------|---|---|---|---|---|---|---|---|----|----|-------|---------------------|----|----|----|----|----|-------|---------------------|----|----|----|----|----|----|
| | | | 8 | 9 | 1 | 2 | 3 | . | 4 | 5 | 6 | | M | W | h | | | | | E | N | E | R | G | Y |
| 1 | 2 | 3 | 4 | 5 | 6 | 7 | 8 | 9 | 10 | 11 | 12 | 13 | 14 | 15 | 16 | 17 | 18 | 19 | 20 | 22 | 23 | 24 | 25 | 26 | 27 |
| Value (aligned right) | | | | | | | | | | | space | Unit (aligned left) | | | | | | space | Item (aligned left) | | | | | | |

Note: The decimal point in the Value is always at character position 8. Therefore whole numbers are aligned right at the decimal point, with trailing zeroes.

Variables Request

The variables request asks the instrument to return the value of one or more requested variables. All totals are transmitted as accumulated totals.

| Command | Description |
|--------------------|---|
| :RVA? | Return all variables |
| :RVD? | Return the default Total and Rate |
| :RV0? ... :RV9? | Return the specific variable. The numbers relate to the position in the variables menu. For example, V0 is Energy, V1 is Power and so on. |

Variables Request and Response Example

The following request is for the only instrument that is connected to the communication port to return the values of all main menu variables.

```
: A 0 0 1 : R V A ? LF CR
```

The following is an example of a hypothetical instrument response. Refer to on page 25 for the list of variables that would be returned for this application.

```
A 0 0 1 2 0 0 2 / 0 3 / 1 4 1 8 : 2 5 : 0 0 0 0 LF CR
      6 . 1 1 6 M W h E N E R G Y LF CR
      1 6 . 5 7 3 M W P O W E R LF CR
1 3 2 0 . 5 3 0 m 3 V O L U M E LF CR
      5 8 . 3 0 0 m 3 / M V - F L O W LF CR
      7 6 2 7 . 1 1 7 K G M A S S LF CR
      3 4 4 . 4 6 0 K G / M M - F L O W LF CR
```

```

2 3 0 . 0 0 0   D E G   C       T E M P       LF CR
      1 . 2 6 0   M P A           P R E S S       LF CR
      0 . 1 7 4   m 3 / K G       S P - V O L     LF CR
2 8 8 6 . 7 6 0   K J / K G       S P - E N T     LF CR

```

L_F C_R

The following message to an instrument, requests the current values for the default rate and total:

```
: A 0 0 1 : R V D ? LF CR
```

The instrument response would be similar to the following:

```

A 0 0 1   2 0 0 2 / 0 3 / 1 4   1 8 : 2 5 : 0 0   0 0 LF CR
      1 2 6 . 4 5 5   m 3           V O L U M E   LF CR
      2 0 . 4 3 7   m 3 / M       V - F L O W   LF CR

```

L_F C_R

Log Request

The log request asks the instrument how many logs it stores in the particular timebase. These are the values described in [Time Settings and Data Logging](#) on page 47.

| Command | Description |
|---------|--|
| :RLH? | Return the number of hourly logs |
| :RLD? | Return the number of daily logs |
| :RLW? | Return the number of weekly logs |
| :RLM? | Return the number of monthly logs |
| :RLY? | Return the number of yearly logs |
| :RLR? | Return the number of log records (non-timebased logging) |

Log Response Example

The following message asks the instrument with address 001 to return the number of hourly logs that the instrument stores:

```
: A 0 0 1 : R L H ? LF CR
```

The instrument response would be similar to the following:

```

A 0 0 1   2 0 0 2 / 0 3 / 1 4   1 8 : 2 5 : 0 0   0 0 LF CR
2 4 LF CR
LF CR

```

Clear Data Request

The clear data request asks the instrument to clear the data in the selected registers.

| Command | Description |
|---------|---|
| :RCN? | Clear the non-accumulated (resettable) totals |
| :RCA? | Clear the accumulated totals |
| :RCL? | Clear the logs except for the “last edited” log |

Clear Data Request Example

The following message asks the instrument with address 001 to clear the logged data that the instrument stores:

```
: A 0 0 1 : R C L ? LF CR
```

The instrument response would be similar to the following:

```
A 0 0 1 2 0 0 2 / 0 3 / 1 4 1 8 : 2 5 : 0 0 0 0 LF CR
LF CR
```

Instrument Information Request

The Instrument Information request asks the instrument to return the general information about the model and version codes. The instrument exception status is returned as a part of the header as it is with the header for all command responses.

| Command | Description |
|---------|--|
| :RIG? | Return the general information about the instrument such as Model number, Application number, Version and Serial numbers etc. These items are returned as a block in the same format as shown on the display in the “Model Info” menu. |

Instrument Information Response Example

The following message asks the instrument with address 001 to return the general information about the instrument:

```
: A 0 0 1 : R I G ? LF CR
```

The following is an example of a hypothetical instrument response:

```

A 0 0 1   2 0 0 2 / 0 3 / 1 4   1 8 : 2 5 : 0 0   0 0 LF CR
5 1 5           M O D E L   - 1 - - F - LF CR
S C 0 1     I N P U T     F - T P - - LF CR
S C 0 1     V E R S     0 1 0 1 . 0 0 1 LF CR
C U S T O M V E R S     0 0 0 0 0 1 LF CR
U N I T     S / N       1 2 3 4 5 6 LF CR
LF CR
| 1 | 2 | 3 | 4 | 5 | 6 | 7 | 8 | 9 | 10 | 11 | 12 | 13 | 14 | 15 | 16 | 17 | 18 | 19 | 20 | 21 | 22 | 23 | 24 | 25 | 26 | 27 | 28 | 29 |

```

Corrupted or Invalid Requests

If the instrument receives a corrupted or incomplete request, there is no response. The instrument discards any partial request and waits for the next enquiry.

If the instrument receives a request message in the correct format, but for a non-existent option, it returns only the message header. For example, if the instrument received the following request variables message :A001:RVT? it will return only the header because there is no T option for the ‘Variables Request’ message.

Modbus RTU Protocol

Modbus RTU (remote terminal unit) is an industry standard protocol that allows the instrument to be easily interfaced to other communication devices.

The instrument implements the Modbus protocol as detailed in the *Modicon Modbus Protocol Reference Guide* PI-MBUS-300 Rev J (June 1996).

Message Format

In RTU mode, messages start with a silent interval of at least 3.5 character times. The first field transmitted is the device address. Following the last transmitted character, a similar interval of at least 3.5 character times marks the end of the message. A new message can begin after this interval. The entire message frame must be transmitted as a continuous stream. A typical message frame is shown below:

| Address | Function | Data | CRC Check |
|---------|----------|---------|-----------|
| 1 byte | 1 byte | n bytes | 2 bytes |

Except for broadcast messages, when a master device sends a query to a slave device, it expects a normal response. One of four possible events can occur from the master’s query:

- If the slave device receives the query without a communication error, and can handle the query normally, it returns a normal response.
- If the slave does not receive the query due to a communication error, no response is returned. The master program has to process a timeout condition for the query.
- If the slave receives the query, but detects a communications error (parity or CRC), no response is returned. The master program has to process a timeout condition for the query.
- If the slave receives the query without a communication error, but cannot handle it (for example, if the request is to read a nonexistent register), the slave will return an exception response informing the master of the nature of the error.

Instrument Address

The address of the instrument is programmable in the range from 1 to 247. Some addresses are reserved according to PI-MBUS-300 and have a special meaning:

- 0 = Broadcast, no response required from slave devices
- 248 to 255 Reserved

Function Codes

The instrument accepts the following function codes:

| Code | Name | Description |
|------|-------------------------|--|
| 03 | Read data register(s) | Obtain the content of one or more 2-byte data registers. |
| 06 | Preset data register | Preset one 2-byte data register. |
| 07 | Read status register | Obtain the content of 1-byte status register. |
| 16 | Preset data register(s) | Preset one or more 2-byte data registers. |

Exception Response

The instrument forms an exception response by adding 80H to the function code and using an exception code as the 1-byte data field in the returned frame. Implemented exception codes are as follows:

| Code | Name | Description |
|------|----------------------|---|
| 01 | Illegal function | The function code is not a legal action for the slave. |
| 02 | Illegal data address | The data address is not a legal address for the slave. |
| 03 | Illegal data value | The data value is not a legal value for the slave. |
| 05 | Acknowledge | The slave has accepted the request and is processing it, but a long duration of time will be required to do so. |
| 06 | Slave device busy | The slave is engaged in processing a long duration program command. The master should re-transmit the message later when the slave is free. |

List of Data Registers

The following tables describe the addresses and meaning of the data registers in the instrument. The registers are grouped in blocks that relate to a particular function of the instrument. The data values are expressed in the engineering units that were selected for the variables when the instrument settings were configured.

Note: Conventional numbering of registers often starts from 1, therefore be aware that “register 1” in this case has “address 0” and so on.

The data registers represent different data types as specified in the tables:

- I - Integer, 2 bytes (Holding Register)
- L - Long Integer, 4 bytes (2 registers)
- P - Programmable Format, 4 bytes (2 registers)

The “Programmable Format” data type for 4-byte (2 registers) data values can be set as either Floating Point or Long Integer. The Floating Point variable is represented in IEEE-754 Floating Point 4-byte format and requires two 2-byte data registers:

| IEEE-754 | Modicon Registers |
|----------|------------------------|
| 1st byte | low byte (register X) |
| 2nd byte | high byte (register X) |

| | |
|-----------------|--------------------------|
| IEEE-754 | Modicon Registers |
| 3rd byte | low byte (register X+1) |
| 4th byte | high byte (register X+1) |

This means that two data registers must be read or written to obtain, or preset, one data value.

Current and Logged Process Data

This block of registers is available for the retrieval of current or logged process data with its matching time and date information.

Use the log type and log number to retrieve the logged information from the appropriate register. If a particular log number does not exist, or the instrument does not have the optional real-time clock, the time and date stamp and associated variables are set to zero.

| Register | Name | Comments | Read Only or Read/Write | Data Type |
|----------|----------------------------|--|-------------------------|-----------|
| 1 | Net Volume | Process Variables By default totals are the Accumulated values. If current Non-accumulated (resettable) totals are required, set register 37 to 06. All logged totals are the Accumulated values. | R | P |
| 3 | Net Flowrate | | R | P |
| 5 | Main Line Volume | | R | P |
| 7 | Main Line Flowrate | | R | P |
| 9 | Process Line Volume | | R | P |
| 11 | Process Line Flowrate | | R | P |
| 13 | Process Ratio | | R | P |
| 15 | Process Control Output | | R | P |
| 17 | Process Flowrate Deviation | | R | P |
| 19 | | | R | P |
| 21 | | | R | P |
| 23 | | | R | P |
| 25 | | | R | P |
| 27 | | | R | P |
| 29 | | | R | P |
| 31 | Year | Current Date/Time or Logged Date/Time Stamp (see register 38 Log Number). Only current Date/Time can be edited | R/W | I |
| 32 | Month | | R/W | I |
| 33 | Date | | R/W | I |
| 34 | Hour | | R/W | I |
| 35 | Minute | | R/W | I |
| 36 | Second | | R | I |
| 37 | Log Type | 00 - hourly or log records 01 - daily 02 - weekly 03 - monthly 04 - yearly 05 - last edit of calibration 06 - current totals are non-accumulated values, register 38 is ignored. | R/W | I |
| 38 | Log Number | If set to 0, current variables and Date/Time are retrieved | R/W | I |

| Register | Name | Comments | Read Only or Read/Write | Data Type |
|----------|------------|---|-------------------------|-----------|
| 39 | Clear Data | 01 - clear logs 02 - clear accumulated totals 03 - clear non-accumulated totals | W | I |
| 40 | Reserved | | | I |

Instrument Exception Status

This register is available to verify the status of the instrument.

| Register | Name | Comments | Read Only or Read/Write | Data Type |
|----------|------------------|---|-------------------------|-----------|
| 41 | Exception Status | 00 = no error 01 = analog input 1 failure 02 = analog input 2 failure 03 = analog input 3 failure 04 = analog input 4 failure 05 = invalid calibration parameter 06 = invalid reference parameter 07 = invalid property 08 to 09 reserved 10 = process parameters out of range 11 = input is over limit 12 = error detected: control failure 20 = system failure 21 = power supply is low 22 = new or failed clock battery 23 to 29 reserved 30 = alarm 1 active 31 = alarm 2 active 32 = alarm 3 active 33 = alarm 4 active | R | I |

Instrument Control and I/O

This block of registers is available in some applications to give access to important information in the instrument.

| Register | Name | Comments | Read Only or Read/Write | Data Type |
|----------|----------------|---|-------------------------|-----------|
| 42 | Reserved | | | I |
| 43 | Logic Inputs | 0 to 15 Binary representation of logic inputs 0 = activated; 1 = deactivated B0 = input 1 (LSB) B1 = input 2 B2 = input 3 B3 = input 4 | R | I |
| 44 | Operation Mode | Representation of operation mode 0 = Idle/Local Idle state 1 = Inhibited Inhibited state | R | I |

| Register | Name | Comments | Read Only or Read/Write | Data Type |
|----------|-----------------------|---|-------------------------|-----------|
| 45 | Relay State | 0 to 15 Binary representation of relay state 0 = open; 1 = closed B0 = relay 1 (LSB) B1 = relay 2 B2 = relay 3 B3 = relay 4 | R | I |
| 46 | Relay Control | 0 to 15 Binary representation of relay control 0 = open; 1 = close B0 = relay 1 (LSB) B1 = relay 2 B2 = relay 3 B3 = relay 4 | R/W | I |
| 47 | Relay Control Source | 0 to 15 Binary representation of relay control source 0 = Local - controlled by instrument operation 1 = RTU - controlled by Modbus register 46 B0 = relay 1 (LSB) B1 = relay 2 B2 = relay 3 B3 = relay 4 | R/W | I |
| 48 to 50 | Reserved | | | I |
| 51 to 99 | Instrument Parameters | See next table for details. | R/W | P |
| 101 | Analog Inp.1 | Raw analog input data | R | P |
| 103 | Analog Inp.2 | 4-20mA inputs are read in Amperes | R | P |
| 105 | Analog Inp.3 | 0-5V or 1-5V inputs are read in Volts RTD inputs are read in degrees Kelvin | R | P |
| 107 | Analog Inp.4 | Unused inputs are configured as 4-20mA | R | P |

Instrument Configuration Parameters

This block of registers is available in applications to give access to some important instrument parameters (i.e. target setpoint, etc).

The usage of these parameters can be dependent on other instrument settings. For full description, please refer to the 'Modbus Accessible Parameters' in [Parameters](#) on page 37.

| Register | Name | Comments | Read Only or Read/Write | Data Type |
|----------|------------------------------|----------|-------------------------|-----------|
| 51 | Loop Control Output Setpoint | | R/W | P |
| 53 | Loop Flowrate Setpoint | | R/W | P |
| 55 | Loop Ratio Setpoint | | R/W | P |
| 57 to 99 | Reserved | | R/W | P |

Printer Protocol

A printer protocol is available in the 500 Series. It provides the ability to print out live data, individual logged data and to do some report-style printing of logged data. The method of printing these and the format of the printouts is described below.

Note: Printer output is only available if the Real Time Clock option is fitted.

The selection of Printer Protocol can be made for the Communications Protocol options for the RS232 or RS485 port. A list of log report types and printer types available at the end of the TM-LOG calibration menu.

Report Types

The list of report types is as follows:

- REP-01 Hourly Logs Report
- REP-02 Daily Logs Report
- REP-03 Weekly Logs Report
- REP-04 Monthly Logs Report
- REP-05 Yearly Logs Report
- REP-06 Previous Day Hourly Logs (0Hr – 23Hr, minimum 48 hourly logs required)

The number of logs printed in each report is determined by the value programmed for each timebase in the TM-LOG menu.

Printer Types

The list of available printers is as follows:

- PRN-01 Generic computer printer
- PRN-02 Generic roll printer (printing first line first)
- PRN-03 Slip Printer TM295
- PRN-04 Label (roll) printer - Citizen CMP30L

Customizing a Printout

A customized printout can be provided which can have up to 4 header lines and 3 footer lines. It is also possible to include or exclude certain main menu items on the printout. If any customizing of the printout is required discuss this with the distributor.

Types of Printouts

Live Data

The RESET key, when in main menu, is shared as the PRINT key if the printer protocol has been selected. A printout will be initiated whenever this key is pressed. If printing is not required, do not select printer protocol.

The format of this printout will be:

Custom Header Line 1
Custom Header Line 2
Custom Header Line 3
Custom Header Line 4

Current Docket No.

Instrument Serial No. & Tag

Current Date & Time & Status

| | | | |
|-----------------------|-------------|--------------------|---|
| <i>Total Variable</i> | <i>unit</i> | <i>value</i> | <i><Resettable total first></i> |
| <i>Total Variable</i> | <i>unit</i> | <i>value (acc)</i> | <i><Accumulated total second></i> |
| <i>Variable</i> | <i>unit</i> | <i>value</i> | |
| <i>Variable</i> | <i>unit</i> | <i>value</i> | |

etc.

Custom Footer Line 1

Custom Footer Line 2

Custom Footer Line 3

----- *<separation line>*

(Note that blank header and footer lines are not printed).

Docket Number

The docket number that appears on the live data printout indicates the print number. This number is cleared when the Accumulated totals are reset. If the Reset Mode is set for Delayed, where a print can be generated without resetting the non-accumulated totals, an additional number in brackets will be shown that indicates the number of prints since the last reset. i.e.

DOCKET No. *000256* *(000036)*

Instrument Serial Number and Unit Tag

The instrument serial number and unit tag is the same as the information shown in the Model Info menu. For more details refer to **Model Information** on page 23

Individual Log Data

When in the Log Menu and while holding the DISPLAY key to view the data of the log of interest the RESET key can be pressed to initiate a printout of that log entry. The printout will have the time and date stamp corresponding to when the log was taken. After the print has been initiated there will be the opportunity to scroll to view another log entry and print again.

Since in each log entry all totals are stored as the Accumulated value, the printout will not have any resettable totals. The format of the printout with this exception is the same as the LIVE DATA printout:

Custom Header Lines

Instrument Serial No. & Tag

Log Date & Time & Status

| | | | |
|-----------------|-------------|--------------|---|
| <i>Variable</i> | <i>unit</i> | <i>value</i> | <i><example: total as Accum only></i> |
| <i>Variable</i> | <i>unit</i> | <i>value</i> | |

etc.

Custom Footer Lines

----- *<separation line>*

Log Report Printing

As there is the likelihood that the reports can be of a considerable length it is strongly recommended that only the 80 Column printer with Z fold (tractor feed) paper be used. This is just as much for the memory storage of the printer as it is for reliable paper supply.

There is a HOLD.SET REPORT PRINT prompt under the main menu with the ability to print the pre-selected type of report. Pressing and holding the SET key for two seconds will initiate the printout. Any of the Log Reports will have the following format:

Custom Header Lines

Title of Report *<internally set, indicates report type>*

Current Date & Time

Instrument Serial No. & Tag

----- *<separation line>*

Log No. Date & Time & Status

| | | | |
|-----------------|-------------|--------------|---|
| <i>Variable</i> | <i>unit</i> | <i>value</i> | <i><example: total as Accum only></i> |
| <i>Variable</i> | <i>unit</i> | <i>value</i> | |

etc.

----- <separation line>
Log No. Date & Time & Status
Variable unit value <example: total as Accum only>
Variable unit value
etc.

----- <separation line>
Log No. Date & Time & Status
Variable unit value <example: total as Accum only>
Variable unit value

ETC

Custom Footer Lines

----- <separation line>

Reports such as “All Hourly Logs” will print in the historical order, and for those logs that have no data (e.g. unit was powered off at the time) the print will show “Data not available”. i.e.

Log No. Date & Time & Status
Variable unit value <example: total as Accum only>
Variable unit value
etc.

----- <separation line>

Log No. Data Not Available

----- <separation line>

Log No. Date & Time & Status
Variable unit value <example: total as Accum only>
Variable unit value
etc.

If the unit is programmed for 0 logs for a particular time base then the report for that time base will only consist of the header and ID information and a “Data Not Available” message. Likewise for the 0Hr to 23Hr report to print the complete report there must be a minimum of 48 hourly logs programmed otherwise “Data Not Available” will be printed for the missing logs.

Custom Header Lines

Title of Report

Current Date & Time
Instrument Serial No. & Tag

Data Not Available

Custom Footer Lines

----- <separation line>

Printer Data Control

Some printers have limited data buffers and are therefore unable to collect all the print data being transmitted. The 500 Series has the capability of software handshaking. The Xon/Xoff characters can be used by any of the printer types to control the flow of data to ensure that data is not lost.

Some printers will also transmit an Xoff character in response to other events such as the printer being off-line, the print head not engaged or the power being removed. The specific behaviour of the printer being used should be noted.

Error Messages

There are two printer error messages that can be displayed.

PAPER OUT

This message is related to the Printer Type PRN-03 TM295 Slip printer. It is standard procedure with this printer to check for paper status before printing. If a print is attempted but there is no paper the PAPER OUT message will be scrolled. The instrument will continue to poll the printer for paper and if paper is detected before a communications timeout expires the print will commence.

COMMS TIMEOUT

This message is relevant for all printer types and will be activated for the following conditions.

1. If the flow of data is stopped due to software or hardware handshaking and is not allowed to resume before the communications timeout.
2. If Printer Type is PRN-03 Slip printer and a paper status is requested but no response is received within the timeout period.
3. Paper Out has been detected for Printer Type PRN-03 but no paper is inserted within the timeout period.

When a communications timeout error has been activated the message COMMS TIMEOUT will be scrolled once, the request to print will be cleared and the instrument will return to its normal mode.

Appendix A

Glossary

| | |
|------------------------------|--|
| ASCII | American Standard Code for Information Interchange. For the ASCII protocol, the instrument receives and transmits messages in ASCII, with all command strings to the instrument terminated by a carriage return. Replies from the instrument are terminated with a line-feed and a carriage-return. |
| IrDA | The Infra-red Developers Association is a group of computer and software manufactures who have agreed on a format for communication among infrared devices. |
| Modbus RTU | The Modbus protocol is a message structure for communications between controllers and devices regardless of the type of network. In RTU (remote terminal unit) mode, each 8-bit byte in a message contains two 4-bit hexadecimal characters. This mode has greater character density than ASCII and allows better data throughput than ASCII for the same baud rate. |
| Normalised Input | A normalised input ranges from 0 to 1.000. For 4-20mA input, the signal is set to 0 at 4mA and the signal is set to 1.000 at 20mA. |
| Passive Output Signal | Requires an external power supply. |

Appendix B

Model Numbers

Product Codes

| Model | Supplementary Code | Description |
|---|--------------------|---|
| 515 | - CR02 | |
| Enclosure | 1 | Panel mount enclosure |
| | 2 | Field mount enclosure (NEMA 4X / IP66) |
| | 3/5 | Explosion proof Ex d (IECEX/ATEX), metric glands (5 specifies heater) |
| | 4/6 | Explosion proof Ex d (CSA), NPT glands (6 specifies heater) |
| Output Options | 0 | 4 logic inputs, 1 isolated output, 2 relays (only relay type 1 is available), RS232 (DB9) communication port |
| | 1 | 4 logic inputs, 2 isolated outputs, 4 relays, real-time clock data logging, RS232 (DB9) and RS485 communication ports |
| | 2/3 | 4 logic inputs, 2 isolated outputs, 4 relays, real-time clock data logging, RS232 (DB9) and Ethernet/RF communication ports (not yet available) |
| Relay Type | 1 | Electromechanical relays only |
| | 2 | 2 electromechanical and 2 solid state relays |
| | 3 | Solid state relays only (not yet available) |
| Power Supply | U | Inputs for 12-28VDC and 100-240 VAC, 50-60Hz <i>(Previous Models: A = 110/120 VAC, E = 220/240 VAC)</i> |
| | D | Input for 12-28VDC power only |
| Display Panel Options | S | Standard option (now with backlight & LCD backup) <i>(original Full option: F, with Infra-Red comms, no longer available)</i> |
| PCB Protection | C | Conformal coating - required for maximum environmental operating range. Recommended to avoid damage from moisture and corrosion. |
| | N | None - suitable for IEC standard 654-1 Climatic Conditions up to Class B2 (Heated and/or cooled enclosed locations) |
| Application Pack Number | CR02 | Defines the application software to be loaded into the instrument |
| For example: Model No. 515.111USC Displayed on the 500 Series as: Note: The first character represents the CPU installed (factory use only). The remaining 6 characters only represent hardware that affects the operation. | | |

Note: Example full product part number is 515.111USC-CR02 (This is the number used for placing orders).

Custom Version Codes

| | Code | | Description |
|--|------|--|---|
| Origin Code Identifies Distributor | 00 | | Factory Default Application |
| | 01 | | Contrec Systems Pty. Ltd. Melbourne Australia |
| | 02 | | Contrec Limited. West Yorkshire UK |
| | 03 | | |
| | 04 | | Contrec - USA, LLC. Pelham AL 35124 USA |
| | 05 | | Flowquip Ltd. Halifax UK |
| | 06 | | |
| | etc. | | |
| User Language | 0 | | English (Default) |
| | 1 | | German |
| | 2 | | Dutch |
| | 3 | | French |
| | 4 | | Spanish |
| | 5 | | |
| | etc. | | |
| Distributor's Code | 000 | | Distributor's own choice. Possibly a code that identifies the customer and the application. |
| | ... | | |
| | 999 | | |
| For example: 02 3 157 Displayed on the 500 Series as: | | | 023 157 CUSTOM VERS |

Application Information Code

The Application Information code is an aid for users and service personnel to determine the type of inputs that are used in a particular application. The Application Information code is displayed on the instrument as shown below.

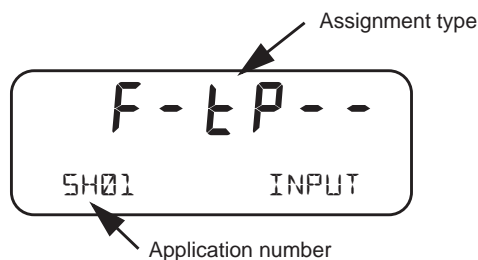

The Application Information code is returned as part of a General Instrument request (as described in [Instrument Information Request](#) on page 62).

The Application number identifies the application as in the following examples:

- SC01 - steam flow computer for frequency flow meter
- GN02 - natural gas flow computer for analog flow meter

The Input Assignment type indicates the physical input that is assigned to each input on the instrument. The code is made up from six characters as follows:

| FINP1 | FINP2 | AINP1 | AINP2 | AINP3 | AINP4 |
|--------------|--------------|--------------|--------------|--------------|--------------|
| X | X | X | X | X | X |

The codes are as follows:

- - - not used in this application
- *A* - indicates a generic analog input such as for density or level
- *d* - indicates a density input
- *F* - indicates a generic flow input such as for volume or mass, (frequency or analog)
- *H* - indicates a high flow input for stacked inputs
- *L* - indicates a low flow input for stacked inputs
- *P* - indicates a pressure input
- *q* - indicates a quadrature input
- *t* - indicates a temperature input.

For example, *F - t P - -* is an instrument with FINP1 (frequency input 1) assigned to a flow input, AINP1 assigned to a temperature input and AINP2 assigned as a pressure input. The other inputs are not used.

Appendix C

Units of Measurement

Available Units of Measurement

The following is a list of the available units of measurement used across the range of 500 Series applications.

| Units Type | Available units of measurement |
|-------------------|---|
| Volume | m ³ , Km ³ , Ltr, mL, Gal, KGal, MGal, ft ³ , kft ³ , Mft ³ , bbl |
| Volume Flowrate | m ³ /s, m ³ /min, m ³ /h, m ³ /D, L/s, L/min, L/h, L/day, mL/s, mL/min, mL/hr, Gal/s, Gal/min, Gal/h, KGal/D, MGal/D, ft ³ /s, ft ³ /min, ft ³ /h, Mft ³ /D, bbl/s, bbl/min, bbl/h, bbl/D |
| Volume K-Factor | P/m ³ , P/Ltr, P/mL, P/Gal, P/ft ³ , P/bbl |
| Mass | kg, g, Ton, lb, Klb |
| Mass Flowrate | kg/s, kg/min, kg/h, g/s, g/min, g/h, Ton/min, Ton/h, Ton/D, lb/s, lb/min, lb/h, Klb/min, Klb/h, Klb/D |
| Mass K-Factor | P/kg, P/g, P/Ton, P/lb, P/Klb |
| Energy | kJ, MJ, GJ, kWh, MWh, kBTU, Ton.h, therm, cal, kcal, Mcal |
| Power | kJ/h, MJ/h, GJ/h, kW, MW, kBT/M, kBT/h, Ton, therm/min, therm/h, kcal/h, Mcal/h |
| Energy K-Factor | P/kJ, P/kWh, P/kBTU, P/Ton.h, P/therm, P/kcal |
| Temperature | Deg K, Deg C, Deg F, Deg R |
| Pressure | Pa, kg/m ² , kg/cm ² , kPa, MPa, mbar, bar, psi, Atm, inH ₂ O, mmH ₂ O |
| Density | kg/m ³ , kg/Ltr, lb/ft ³ , SG60F |
| Specific Volume | m ³ /kg, L/kg, ft ³ /lb |
| Specific Enthalpy | kJ/kg, BT/lb, cal/g, cal/kg, kcal/kg, Mcal/kg |
| Reynolds Number | E+0, E+3, E+6 (scaling for unitless variable) |
| Length (Level) | m, mm, cm, INCH, FOOT |
| Velocity | m/s, m/M, m/h, ft/s, ft/M, ft/h |
| Length K-Factor | P/m, P/cm, P/INCH, P/FOOT |
| Area | m ² , ft ² |
| Ratio | % |
| General Input | Pressure, Temperature, Density, Length (Level), Factor, Volume |

Index

Numerics

- 0-5V input 11
- 4-20mA
 - input 11
 - output 13

A

- ACCUM key 20
- address, instrument 58
- alarm
 - connection 14
 - delay 45
 - equipment failure 44
 - hysteresis 45
 - relays 44
 - setpoint 44
- alarms menu 44
- analog input
 - connections 11
 - scaling 2
- application code 78
- approvals 4
 - FCC Declaration 4
- ASCII protocol 57

B

- back panel 10
- battery
 - failed 53
 - life 47
 - new 53
- baud rate 46

C

- calibration
 - menu 34
 - set mode 32
 - view mode 31
- clock
 - battery 47
 - date format 48
 - real-time 47

codes

- application information 78
 - customer version 78
 - exception 67
 - product number 77
- ## communication
- connections 15
 - protocols 57
- ## communications 3, 55
- menu 45
- ## connections
- alarm 14
 - communication 55
 - communications 15
 - electrical 10
 - input 11
 - output 13
- ## control loop
- tuning 27
- ## control modes 24
- customer version codes 78
 - customizing a printout 69

D

- daily logging 48
- data log
 - viewing 22
- data logging
 - daily 48
 - hourly 48
 - monthly 48
 - weekly 48
 - yearly 48
- date format 48
- declaration FCC 4
- default total 19
- default variable 19
- delay, alarm 45
- display
 - specifications 7
 - timeout mode 50
 - timeout time 50

DISPLAY key 20, 21
display-only parameter 31

E
earthing 17
electrical connections 10
equipment failure alarm 44
error messages 53
exception codes 67
Exception Status 59

F
features 1
flash driver port assignment 47
flushing 27
format, date 48
front panel
 keys 20
 LEDs 20

G
glossary 75

H
hardware connections 55
hourly logging 48
hysteresis, alarm 45

I
infra-red port 45, 56
inhibit active signal 27
inhibit process flow 27
input
 0-5V 11
 4-20mA 11
 connections 11
 analog 11
inputs menu 39
installation 9
instrument
 address 58
 request format 58
 responses 59
 settings 36
interconnections, communication 55
interference suppression 15
isolated outputs 3

K
key
 ACCUM 20
 DISPLAY 20, 21
 RATE 20
 RESET 20
 TOTAL 20
keys, front panel 20

L
LEDs, status 20
logged data 22
 viewing 22
logging
 daily 48
 hourly 48
 monthly 48
 weekly 48
 yearly 48
logic input connection 12
logic input control 27

M
main menu items 21
menu
 alarms 44
 calibration 34
 comms 45
 inputs 39
 outputs 41
 params 37
 setup 50
 test 51
 tm/log 47
 units 36
messages
 error 53
 system 52
 warning 53
Modbus accessible parameters 38
Modbus data format 46
Modbus RTU protocol 63
mode
 display timeout 50
 normal operation 19
 process control 24
 set calibration 32
 view calibration 31
model numbers 77

monthly logging 48
mounting 9

N

normal mode 19
number
 model 77
 serial 24

O

operation, control modes 24
operation, normal mode 19
output
 connections 13
 4-20mA 13
 pulse 14
 pulse factor 43
outputs menu 41

P

panel
 LEDs 20
 mounting 9
 rear 10
parameter
 display-only 31
 not visible 31
 password-protected 31
 programmable 31
parameters menu 37
parity bits 46
password-protected parameter 31
peak flowrates 21
port
 assignment, flash driver 47
 flash driver assignment 47
 infra-red 45, 56
 RS-232 16, 45, 55
 RS-485 16, 45, 56
power supply interruption 47
printer
 data control 73
 error messages 73
 protocol 69
 report types 69
printer types 69

printouts
 individual logs 71
 live data 70
 log report 71
 types 70
product number codes 77
programmable parameters 31
protocol
 ASCII 57
 communication 57
 Modbus RTU 63
 printer 69
pulse factor, output 43
pulse output 14

R

RATE key 20
real-time clock 47
rear panel 10
relay outputs 3
relays, alarm 44
RESET key 20
responses, instrument 59
RS-232 port 16, 45, 55
RS-485 port 16, 45, 56
RTU protocol 63

S

scaling analog input 2
serial number 24
setpoint, alarm 44
settings
 instrument 36
setup menu 50
shielding 17
snubber 15
specifications 7
standards 4
status LEDs 20
stop bits 46
suppression, interference 15
system
 errors 53
 messages 52
 warnings 53

T

terminal designations 10
test menu 51

timeout
 mode 50
 time 50
tm/log menu 47
TOTAL key 20
total, default 19
trim control
 tuning 28
tuning control loop 27
tuning trim control 28

U

unit tag 24
units
 menu 36

V

variable, default 19
version, customer 78
view data logs 22

W

warnings 53
weekly logging 48

Y

yearly logging 48