

Model 515 Flow Computer

Operation Manual

Application SC04

Steam
Flow Computer
for
Stacked Differential Pressure Meters
(ISO 5167 & V-Cones)



30 August 2021

Model 515 Flow Computer - Operation Manual

© Contrec Limited 2021

The instructions given herein cover the general description, installation, operation and maintenance of the subject equipment. Contrec Limited. reserves the right, without prior notice, to make engineering refinements that may not be reflected in this manual.

Should any questions arise which cannot be answered specifically by this manual, they should be directed to Contrec Limited for further detailed information and technical assistance.

Contrec Limited will not accept any liability for either direct or consequential damages resulting from the use or misapplication of the contents of this manual.

Part of the software embedded in this product is eCos - Embedded Configurable Operating System, a trademark of Red Hat. Portions created by Red Hat are Copyright © 1998, 1999, 2000 Red Hat, Inc. (<http://www.redhat.com>). All rights reserved

The software in this product was in part provided by Red Hat and any express or implied warranties, including, but not limited to, the implied warranties of merchantability and fitness for a particular purpose are disclaimed. In no event shall the author be liable for any direct, indirect, incidental, special, exemplary, or consequential damages (including, but not limited to, procurement of substitute goods or services; loss of use, data, or profits; or business interruption) however caused and on any theory of liability, whether in contract, strict liability, or tort (including negligence or otherwise) arising in any way out of the use of this software, even if advised of the possibility of such damage.

Contrec Limited
Riverside, Canal Road, Sowerby Bridge,
West Yorkshire HX6 2AY UNITED KINGDOM
Tel: +44 1422 829944
Email: sales@contrec.co.uk

Website: www.contrec.co.uk

Contrec Systems Pty Ltd
5 Norfolk Avenue Ringwood, Melbourne 3134 AUSTRALIA
Tel: +61 4 413 505 114
Email: info@contrec.com.au

Contrec - USA, LLC
916 Belcher Drive Pelham AL 35124 USA
Tel: +1 (205) 685 3000 Fax: +1 (205) 685 3001
Email: contrec@contrec-usa.com



Publication No: 515-SC04-OM - 30 August 2021



Safety Notice

The information in this safety notice is for the prevention of injury to personnel and damage to the instrument.

The manufacturer assumes no liability for injury or damage caused by misuse of the instrument or for modifications made to the instrument.

This document must be consulted in all cases where the following “Caution” safety symbol is used : 

Qualified Personnel

The instrument must be installed, operated and serviced by persons who have been properly trained and authorised. Personnel must read and understand this manual prior to installation and operation of the instrument. Refer to section 3 for further information regarding permitted maintenance operations. The safety of any system incorporating the equipment is the responsibility of the assembler of the system.

Static Hazard

The 500 series flow computer uses high speed CMOS circuitry which is sensitive to static damage. The user should observe accepted safety practices for handling electronic devices, especially during servicing. Once the unit is installed, grounded and interconnected, the chances of static damage are greatly reduced.

Voltage Hazard

Before connecting power to the instrument, ensure that the supply voltage for the AC or DC input is suitable. The AC voltage rating is as stated on the instrument rating plate. Personnel should take all due care to avoid electric shock. **For safe operation it is essential to connect a mains safety earth to the A.C. power inlet.** Do not operate at altitudes above 2000m.

Welding Hazard

Do not perform electric welding in close proximity to the instrument or its interconnecting cables. If welding in these areas must be performed, disconnect all cables from the instrument. Failure to do so may result in damage to the unit.

Moisture Hazard

To avoid electrical faults and corrosion of the instrument, do not allow moisture to remain in contact with the instrument. Operate only in a clean, dry and pollutant-free environment.

Operating & Storage Temperature

Operating: If a heater is being used, **DO NOT** isolate the instrument in temperatures below -20°C.

Storage: **DO NOT** store the equipment below -20°C.

Disconnection Device

When powered from a mains supply this unit requires the provision of a suitable mains isolation device, capable of interrupting both poles of the supply and meeting your local wiring regulations, to be suitably located and easily accessible near to the installed instrument. It must be marked as the disconnecting device for the equipment. It must be suitably rated with respect to the cross sectional area of the supply conductors.

Instrument Disposal

Contrec instrumentation should not be thrown into the general waste system.

If within EU member states, this instrument should be disposed of according to the guidelines set by the WEEE (Waste Electrical and Electronic Equipment) directive 2012/19/EU. If outside of the EU, this equipment should be responsibly disposed of according to local and national regulations for EEE (Electrical and Electronic Equipment).



By not discarding of this product along with other house hold waste you are preserving natural resources and reducing waste sent to landfill and incinerators.

Remove batteries and dispose of separately (see *Disposal of Batteries*) before disposal of Contrec instrumentation.

Disposal of Batteries

Batteries have an environmental impact. Safe and responsible disposal should be undertaken.

In all EU member states, as per Directive 2006/66/EC, batteries must not be thrown away with general waste. Contact your local environmental authority for information regarding disposal or recycling of used batteries, alternatively they can be returned directly to Contrec Ltd. for disposal.



Please Contact Contrec Ltd before returning batteries for disposal.

Explanation of IEC Symbols Used

You should familiarise yourself with the following symbols which are used both within this manual and on the instrument itself.



This document must be consulted in all cases where the following “Caution” safety symbol is used.



DC Input (DC).



AC Input (AC).



Protective Earth Terminal.

Contents

1 Introduction

Features	1
Overview	1
Operation Modes	2
Specific Enthalpy & Energy Offset	2
Calculations	3
Analog Input Scaling	4
Displayed Information	4
Main Menu Variables	5
Communications	5
Isolated Outputs	5
Relay Outputs	6
Software Configuration	6
Analog Input Types	6
Limitations of Use	7
Approvals	8

2 Specifications

Specification Table	9
---------------------	---

3 Installation & Maintenance

Installation Instructions	11
Cleaning and Decontamination	11
Panel Mounting	11
Electrical Connection	12
Rear Panel Connections	12
Terminal Designations	13
Terminal Wiring Insulation	14
Relay Wiring	14
Mains Power Wiring	14
Inputs	15
Analog Input Connections	15
Logic Input Connection	17
Outputs	18
4-20mA Output Connection	18
Pulse Output Connection	19
Control Relays (Alarms)	20
RC Network for Interference Suppression	21
Communications	22
COM-1 RS-232 Port	22
COM-2 RS-485 Port Option	22
COM-2 Ethernet Port Option	23
Mains Connection	23
Earthing and Shielding	23
Disconnection Device	23
Maintenance Instructions	23
Battery Replacement	24
Battery Type	24

4 Operation	
Normal Operation	25
Default Total	25
Status LEDs	25
Front Panel Keys	26
Remote Reset	26
Main Menu Items	27
Detail and Basic Menu	28
Peak Flowrates	28
Data Logs	28
Model Information	30
5 Instrument Calibration	
Introduction	31
Calibration View Mode	32
Calibration Set Mode	32
Changing the Instrument Settings	34
Program Backup & Reports	35
Backup via 500 Series Program Manager	35
Printing Configuration Report	35
Upload and Clone of Application Software	35
Calibration Menu Tree	36
Instrument Settings	38
Units of Measurement	38
Parameters	39
Inputs	41
Outputs	46
Alarms	48
Communications	51
Time Settings and Data Logging	52
General Setup Parameters	55
Test Menu	58
System Messages	59
Error Messages	59
Warning Messages	61
6 Communications	
Overview	63
Hardware Interconnection	63
Protocols	65
Simple ASCII Protocol	65
Requests Format	65
Instrument Responses	67
Corrupted or Invalid Requests	70
Modbus RTU Protocol	71
List of Data Registers	73
Printer Protocol	77
Types of Printouts	78

Printer Data Control	81
Appendix A Glossary	
Glossary	83
Appendix B Model Numbers	
Product Codes	85
Custom Version Codes	86
Application Information Code	86
Appendix C Ethernet Port & Setup	
Ethernet Port	88
Connecting 515 Ethernet to Networks/Routers	88
Connecting DataMod via Ethernet	89
Appendix D Reference Tables	
Properties of Commonly Used Materials	90
Index	91

List of Figures

1	Typical Application Diagram	6
2	500 Series Instrument Panel Mounting	11
3	Rear Panel Connections - Original	12
4	Rear Panel Connections - New RS485 Version	12
5	Rear Panel Connections - New Ethernet Version	13
6	Externally Powered Voltage Transmitter	15
7	Internally Powered Voltage Transmitter	15
8	Externally Powered Current Loop	16
9	Internally Powered Current Loops	16
10	RTD Connection	17
11	Logic Inputs Connection Diagram	18
12	Output 4-20mA Connection Diagram	19
13	Output Pulse Connection Diagram	19
14	Relay Connection Diagram	20
15	RS-485 Interface Connections	22
16	Logged Data Display Methods	29
17	Calibration Menu Tree Sheet 1	36
18	Calibration Menu Tree Sheet 2	37
19	RS-232 Cable Connections to a Computer	63
20	RS-485 Connections	64
21	DataMod - Modbus Connection Settings	89

Chapter 1

Introduction

Features

- Tailored for differential pressure meters with single or stacked transmitters
- Uses IAPWS-IF97 steam calculation
- Suitable for Water, Saturated and Superheated steam applications
- Allows for Specific Enthalpy (initial energy) offset
- ISO 5167 (2003) DP flow calculations, 9 meter types
- V-Cone DP flow calculations, 2 cone types
- Selection of Detail or Basic main menu to suit operator and application
- Selection of second language and user tags
- RTC logging with over 1000 entries
- Programmable pulse width and scaling of pulse output
- 4-20mA retransmission
- RS232 and RS485 or Ethernet (optional) serial ports
- Modbus RTU, Printer and other serial port protocols
- Front panel adjustment of 8-24V DC output voltage
- Backlit display

Overview

The 515 SC04 application measures the volume, mass and energy content of steam by using single or stacked differential pressure flow inputs in conjunction with temperature and pressure inputs.

A selection of various modes makes it suitable for many steam applications. Flow is calculated according to equations for ISO 5167 or V-Cone meters and accurately accounts for thermal expansion effects.

The energy calculations are based on the IAPWS Industrial Formulation (1997) for the thermodynamic properties of steam. Pressure and temperature values are used to determine the specific volume and enthalpy. The instrument also calculates the isentropic exponent and absolute viscosity which are required for the differential pressure flowrate calculations. A specific enthalpy adjustment can be used to offset any initial energy.

Operation Modes

This instrument can be used for saturated/superheated steam or water applications by selecting one of the following operation modes in calibration:

- **SAT-T** - Saturated steam using temperature input only
- **SAT-P** - Saturated steam using pressure input only
- **SUPER-1** - Superheated steam (standard).
- **SUPER-2** - Superheated steam, uses default temperature and pressure when outside the superheated region.
- **SUPER-3** - Superheated steam, uses saturated steam curve and pressure input when outside the superheated region.
- **LIQUID** - Liquid water, applications such as boiler feed or condensate return measurement.

The operation mode can be observed via Modbus RTU communications. Please refer to **Instrument Control and I/O** on page 75 for further details.

Specific Enthalpy & Energy Offset

In some applications it is the total energy contained in the flowing water or steam that is of interest, while in other application it is the energy used to create the heated water or steam that is important. When it is the 'energy used' that is required to be calculated, it is necessary to offset the energy and power readings with the initial heat energy in the boiler feed or water source.

This is achieved by using the steam tables to calculate the initial specific enthalpy based on the pre-entered reference conditions of the source. A specific enthalpy adjustment value is then deducted from the specific enthalpy of the flowing steam or water.

If the specific enthalpy adjustment option is enabled, the resultant net specific enthalpy is then used to calculate the energy and power consumed.

The specific enthalpy values are displayed in the main menu, while the adjustment feature can be enabled or disabled and the adjustment reference conditions entered in program mode. An error will be raised on exit of program mode if the temperature and pressure reference condition are out of range.

It is also deemed to be an invalid condition to have the specific enthalpy adjustment value greater than the measured flowing value. In this situation the net specific enthalpy value will be fixed to zero and the energy and power will cease to be calculated.

Calculations

The following equations identify the derivation of some of the displayed variables. If your interest is more in the operation of the instrument, you can skip this section and allow the instrument to take care of the calculations.

The steam energy calculations are based on the IAPWS Industrial Formulation (1997).

Superheated steam regions are:

$$\begin{array}{ll} 0^{\circ}\text{C} < t < 800^{\circ}\text{C} & P < 100\text{MPa} \\ 32^{\circ}\text{F} < t < 1472^{\circ}\text{F} & P < 14500\text{psia} \end{array}$$

$$\begin{array}{ll} 800^{\circ}\text{C} < t < 2000^{\circ}\text{C} & P < 10\text{MPa} \\ 1472^{\circ}\text{F} < t < 3632^{\circ}\text{F} & P < 1450\text{psia} \end{array}$$

Saturated steam regions are:

$$\begin{array}{l} 0^{\circ}\text{C} < t < 374^{\circ}\text{C} \text{ (critical temperature)} \\ 32^{\circ}\text{F} < t < 705^{\circ}\text{F} \end{array}$$

$$\begin{array}{l} P < 22\text{MPa} \text{ (critical pressure)} \\ P < 3190\text{psia} \end{array}$$

Water region is:

$$\begin{array}{l} 0^{\circ}\text{C} < t < t_{\text{saturation}} \text{ at system pressure} \\ 32^{\circ}\text{F} < t < t_{\text{saturation}} \text{ at system pressure} \end{array}$$

Formulas

$$\begin{array}{l} \text{Volume flow} = \text{Mass flow} \times \text{Specific volume} \\ \text{Energy flow} = \text{Mass flow} \times \text{Net SE} \end{array}$$

$$\begin{array}{l} \text{Net SE} = \text{SE} - \text{SEadj} \text{ (if SE} > \text{SEadj otherwise 0)} \\ \text{(SE = Specific Enthalpy)} \end{array}$$

Note: Specific Enthalpy Adjustment (SEadj) can be disabled or enabled in programming to suit a specific application.

Differential Pressure Equations

This application uses the following general formula for mass flow as per the ISO 5167 (2003) standard:

$$q_m = \frac{C}{\sqrt{1 - \beta^4}} \varepsilon \frac{\pi}{4} d^2 \sqrt{2\Delta P \rho}$$

where:

$$q_m = \text{mass flow}$$

C	=	coefficient of discharge
β	=	diameter ratio of orifice to pipe
ε	=	fluid expansion factor
π	=	universal constant (3.14159)
d	=	diameter of orifice (bore)... (for cone type meters substitute d^2 with $D^2\beta^2$)
D	=	diameter of pipe
ΔP	=	differential pressure
ρ	=	density at flow conditions

For further details of these equations or restrictions of use please refer to the appropriate standard or relevant documents.

Analog Input Scaling

The analog inputs in this instrument are scaled by the following general formula:

$$f(A) = P_{min} + (P_{max} - P_{min}) \cdot A^*$$

where:

P_{min}	=	minimum point (equivalent to offset)
P_{max}	=	maximum point ($P_{max} - P_{min}$ is equivalent to span)
A^*	=	normalised signal (0 to 1) with correction applied for a flow input

Correction Type

- LINEAR: $A^* = A$ when the instrument is not required to apply correction
- NON-LINEAR: $A^* = A_c$ when the instrument applies correction from the points in the correction table

Displayed Information

The front panel display shows the current values of the input variables and the results of the calculations.

The instrument can be supplied with a real-time clock for data logging of over 1000 entries of the variables as displayed on the main menu.

This application indicates the type of pressure value being displayed as either gauge or absolute by adding an 'A' or 'G' to the units of measurement.

Main Menu Variables

Main Menu Variables	Default Units	Variable Type
Energy	MWh	Total
Power	MW	Rate
Volume	m ³	Total
Volume Flowrate	m ³ /min	Rate
Mass	kg	Total
Mass Flowrate	kg/min	Rate
Temperature	Deg C	Rate
Pressure	MPa	Rate
Specific Volume	m ³ /kg	Rate
Specific Enthalpy	kJ/kg	Rate
Specific Enthalpy Adjust	kJ/kg	Rate
Specific Enthalpy Net	kJ/kg	Rate
Differential Pressure	kPa	Rate
Reynolds Number	E+3	Rate

Units of Measurement

In the 500 Series instruments there is a wide range of available units of measurement to be selected from. These can be viewed and selected either during initial Software Configuration via the 500 Series Program Manager (see below) or from within the instrument's calibration settings (if access has been granted) as per [Units of Measurement](#) on page 38.

Communications

There are two communication ports available as follows:

- COM-1 RS-232 port
- COM-2 RS-485 port (optional) or Ethernet (optional)

All types of ports can be used for remote data reading, while RS-232 and RS-485 serial ports can be used for printouts and for uploading and downloading of the application software to the instrument.

Isolated Outputs

The opto-isolated outputs can re-transmit any main menu variable. The type of output is determined by the nature of the assigned variable. Totals are output as pulses and rates are output as 4-20mA signals. One output is standard, a second output is available as an option.

Relay Outputs

The relay alarms can be assigned to any of the main menu variables of a rate type. The alarms can be fully configured including hysteresis. Two relays are standard with two additional relays available as an option.

Software Configuration

The instrument can be programmed to suit the particular application needs and the flexible I/O can be assigned as required. Program settings can be changed either via the front panel (depending on assigned access levels) or via the 500 Series Program Manager (500-PM software).

The 500-PM software is a free comprehensive configuration tool and resource centre that can be used to further tailor an instrument to suit specific application needs including units of measurement, custom tags and text, access levels and more.

The software is a Windows based program that is freely available from the download section of the Contrec website. The program can be used to create a custom version of an existing application to be saved for backup purposes and/or to generate a PDF of configuration report for record keeping.

The instrument stores all set-up parameters, totals and logged data in non-volatile memory with at least 30 years retention.

Analog Input Types

Any analog input can be set to accept a 4-20 mA, 0-5 V or 1-5V signal, while any inputs assigned to a temperature sensor can also be set to accept a PT100 or PT500 signal.

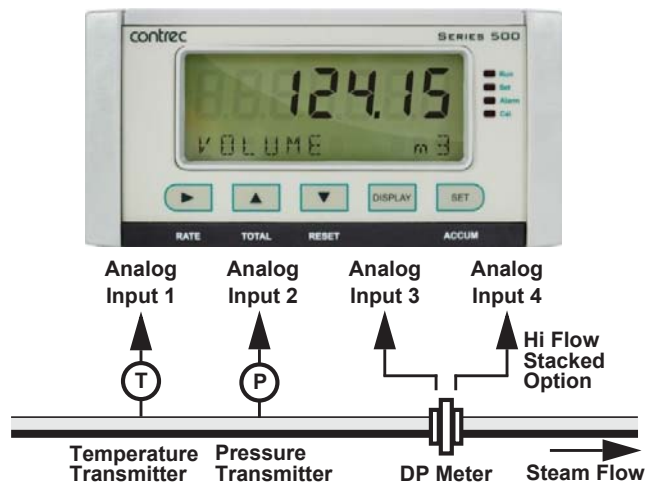

Figure 1 Typical Application Diagram

Limitations of Use

ISO 5167 Limits

The formulae in ISO 5167 can be applied only when the quantities lie within the limits shown in the table below.

The ISO standard applies only to pressure differential devices in which the flow remains subsonic throughout the measuring section and is steady or varies only slowly with time and where the fluid can be considered as single phase. In addition, each of these devices can only be used within specified limits of pipe bore size (D) and Reynolds number (Re_D).

The calculations are based on upstream temperature and pressure values. However, the ISO standard assumes that the downstream temperature is the same as the upstream temperature, therefore a downstream temperature probe is permissible except where very accurate measurements are required.

If the fluid is a gas, the pressure ratio shall be ≥ 0.75 .

Type of device	d (mm) (in)	D (mm) (in)	β	Re_D
Orifice plate, corner or D-D/2 tappings	≥ 12.5 ≥ 0.5	$50 \leq D \leq 1000$ $2 \leq D \leq 40$	$0.10 \leq \beta \leq 0.75$	$Re_D \geq 5000$ for $0.10 \leq \beta \leq 0.56$ $Re_D \geq 16000 \beta^2$ for $\beta > 0.56$
Orifice plate flange tappings	≥ 12.5 ≥ 0.5	$50 \leq D \leq 1000$ $2 \leq D \leq 40$	$0.10 \leq \beta \leq 0.75$	$Re_D \geq 5000$ and $Re_D \geq 170 \times \beta^2 D$ (D in millimetres)
ISA 1932 nozzle	-	$50 \leq D \leq 500$ $2 \leq D \leq 20$	$0.30 \leq \beta \leq 0.80$	$7.0e+04 \leq Re_D \leq 1.0e+07$ for $0.30 \leq \beta \leq 0.44$ $2.0e+04 \leq Re_D \leq 1.0e+07$ for $0.44 \leq \beta \leq 0.80$
Long radius nozzle	-	$50 \leq D \leq 630$ $2 \leq D \leq 25$	$0.20 \leq \beta \leq 0.80$	$1.0e+04 \leq Re_D \leq 1.0e+07$
Venturi tube as cast	-	$100 \leq D \leq 800$ $4 \leq D \leq 32$	$0.30 \leq \beta \leq 0.75$	$2.0e+05 \leq Re_D \leq 2.0e+06$
Venturi tube machined	-	$50 \leq D \leq 250$ $2 \leq D \leq 10$	$0.40 \leq \beta \leq 0.75$	$2.0e+05 \leq Re_D \leq 1.0e+06$
Venturi tube welded	-	$200 \leq D \leq 1200$ $8 \leq D \leq 48$	$0.40 \leq \beta \leq 0.70$	$2.0 e+05 \leq Re_D \leq 2.0e+06$
Venturi nozzle	≥ 50 ≥ 2	$65 \leq D \leq 500$ $2.5 \leq D \leq 20$	$0.316 \leq \beta \leq 0.775$	$1.5e+05 \leq Re_D \leq 2.0e+06$

V-Cone Limits

The formulae used, when either of the cone types (V-Cone or Wafer-Cone) are selected, have been supplied by McCrometer. The accuracy and applicability of the use of these differential pressure flowmeters should be confirmed by referring to the manufactures documentation.

Some applicable ranges of lines sizes and beta values are as follows:

Type of Cone	Line sizes(mm) (in)	β
McCrometer Precision tube V-Cone	$12 \leq D \leq 1830$ $0.5 \leq D \leq 72$	$0.45 \leq \beta \leq 0.80$
McCrometer Wafer-Cone	$12 \leq D \leq 152$ $0.5 \leq D \leq 6$	$0.45 \leq \beta \leq 0.80$

Approvals

This instrument conforms to the EMC-Directive of the Council of European Communities 2014/30/EU, the LVD safety directive 2014/35/EU and the following standards:

- *EN61326:2013* Electrical equipment for measurement, control and laboratory use – EMC requirements: Industrial Environment.
- *EN61010:2010* Safety requirements for electrical equipment for measurement, control, and laboratory use.

In order to comply with these standards, the wiring instructions in **Chapter 3 - Installation & Maintenance** must be followed.

FCC Declaration

This equipment has been tested and found to comply with the limits for a Class A digital device, pursuant to Part 15 of the FCC Rules. These limits are designed to provide reasonable protection against harmful interference when the equipment is operated in a commercial environment. This equipment generates, uses, and can radiate radio frequency energy and, if not installed and used in accordance with the instruction manual, might cause harmful interference to radio communications. Operation of this equipment in a residential area is likely to cause harmful interference, in which case the user will be required to correct the interference at his own expense.

Properly shielded and grounded cables and connectors must be used in order to meet FCC emission limits. Contrec Ltd is not responsible for any radio or television interference caused by using other than recommended cables and connectors or by unauthorized changes or modifications to this equipment. Unauthorized changes or modifications could void the user's authority to operate the equipment.

This device complies with Part 15 of the FCC Rules. Operation is subject to the following two conditions: (1) this device might not cause harmful interference, and (2) this device must accept any interference received, including interference that might cause undesired operation.

Chapter 2

Specifications

Specification Table

<p>Operating Environment</p> <p>Temperature +5°C to +40°C (standard - no coating) -20°C to +60°C (with conformal coating) -30°C to +60°C (ExD housing with heater)</p> <p>Humidity 0 to 95% non condensing (conformal coating) 5% to 85% non condensing (no coating)</p> <p>Power Supply 100-240 V AC (+/-10%) 50-60 Hz (+/-10%) or 12-28 V DC</p> <p>Consumption 10W (max) Overvoltage category II</p> <p>Protection Sealed to IP65 (Nema 4X) when panel mounted</p> <p>Dimensions (panel option) 147mm (5.8") width 74mm (2.9") height 170mm (6.6") depth (behind the panel)</p>	<p>Analog Input (General)</p> <p>Overcurrent 100mA absolute maximum rating (30mA for 4-20mA inputs)</p> <p>Update Time < 1.0 sec</p> <p>Configuration RTD, 4-20mA, 0-5V and 1-5V input</p> <p>Non-linearity Up to 20 correction points (some inputs)</p>
<p>Display</p> <p>Type Backlit LCD with 7-digit numeric display and 11-character alphanumeric display</p> <p>Digits 15.5mm (0.6") high</p> <p>Characters 6mm (0.24") high</p> <p>LCD Backup Last data visible for 15min after power down</p> <p>Update Rate 0.3 second</p>	<p>RTD Input</p> <p>Sensor Type PT100 & PT500 to IEC 751</p> <p>Connection Four Wire</p> <p>Range -200°C to 350°C -200°C to 800°C (PT100 extended range)</p> <p>Accuracy 0.1°C typical 0.2°C typical (PT100 extended range)</p>
<p>Non-volatile Memory</p> <p>Retention > 30 years</p> <p>Data Stored Setup, Totals and Logs</p>	<p>4-20mA Input</p> <p>Impedance 100 Ohms (to common signal ground)</p> <p>Accuracy 0.05% full scale (20°C) 0.1% (full temperature range, typical)</p>
<p>Approvals</p> <p>Interference CE compliance</p> <p>Enclosure IECEx, ATEX and CSA approved enclosures available for hazardous areas</p>	<p>0-5 or 1-5 Volts Input</p> <p>Impedance 10MOhms (to common signal ground)</p> <p>Accuracy 0.05% full scale (20°C) 0.1% (full temperature range, typical)</p>
<p>Real Time Clock (Optional)</p> <p>Battery Type 3 volts Lithium button cell - For Issue 7 option card, type CR2450N manufactured by Renata only - For conformal coated 'C' version, type BR2032 manufactured by Panasonic only - For non-conformal coated versions, type BR2032 and CR2032 manufactured by Panasonic or Sony</p> <p>Battery Life 5 years (typical)</p>	<p>Logic Inputs</p> <p>Signal Type CMOS, TTL, open collector, reed switch</p> <p>Overvoltage 30V maximum</p>
	<p>Relay Output</p> <p>No. of Outputs 2 relays plus 2 optional relays</p> <p>Voltage 250 volts AC, 30 volts DC maximum (solid state relays use AC only)</p> <p>Current 3A maximum - mechanical relays 1.5A maximum - solid state relays</p>

Communication Ports

Ports	COM-1 RS-232 port COM-2 RS-485 or Ethernet port (optional)
Baud Rate	2400 to 19200 baud
Parity	Odd, even or none
Stop Bits	1 or 2
Data Bits	8
Protocols	ASCII, Modbus RTU, Modbus TCP/IP (Ethernet Port), Printer

Transducer Supply

Voltage	8 to 24 volts DC, programmable
Current	70mA @ 24V, 120mA @ 12V maximum
Protection	Power limited output

Isolated Output

No. of Outputs	2 configurable outputs
Configuration	Pulse/Digital or 4-20mA output

Pulse/Digital Output

Signal Type	Open collector
Switching	200mA, 30 volts DC maximum
Saturation	0.8 volts maximum
Pulse Width	Programmable: 10, 20, 50, 100, 200 or 500ms

4-20mA Output

Supply	9 to 30 volts DC external
Resolution	0.05% full scale
Accuracy	0.05% full scale (20°C) 0.1% (full temperature range, typical)

Important: Specifications are subject to change without notice.

Chapter 3

Installation & Maintenance

Installation Instructions



The safety of any system incorporating the equipment is the responsibility of the assembler of the system and should be installed such that there is no risk of impact damage.

This instrument is intended for fixed installation only, e.g. within a panel or cabinet, and is not intended for desktop use. It is not suitable for outdoor use unless fitted into an appropriate outdoor enclosure with a minimum type 3, IP54, rating. The instrument has a 'Pollution degree II' rating.

Cleaning and Decontamination

For general maintenance or to clean an instrument suitable for return to a service centre for repair or inspection, use only a damp cloth and mild detergent. Do not use abrasive cleaners or high pressure water jets. An instrument must be decontaminated before returning.

Panel Mounting

The instrument should be located in an area with a clean, dry atmosphere that is also relatively free of shock and vibration.

The standard mounting procedure is panel mounting in a cutout that is 139mm wide by 67mm high. Two side clips secure the unit into the panel.

Figure 2 shows the panel mounting requirements for the 500 Series Instrument.

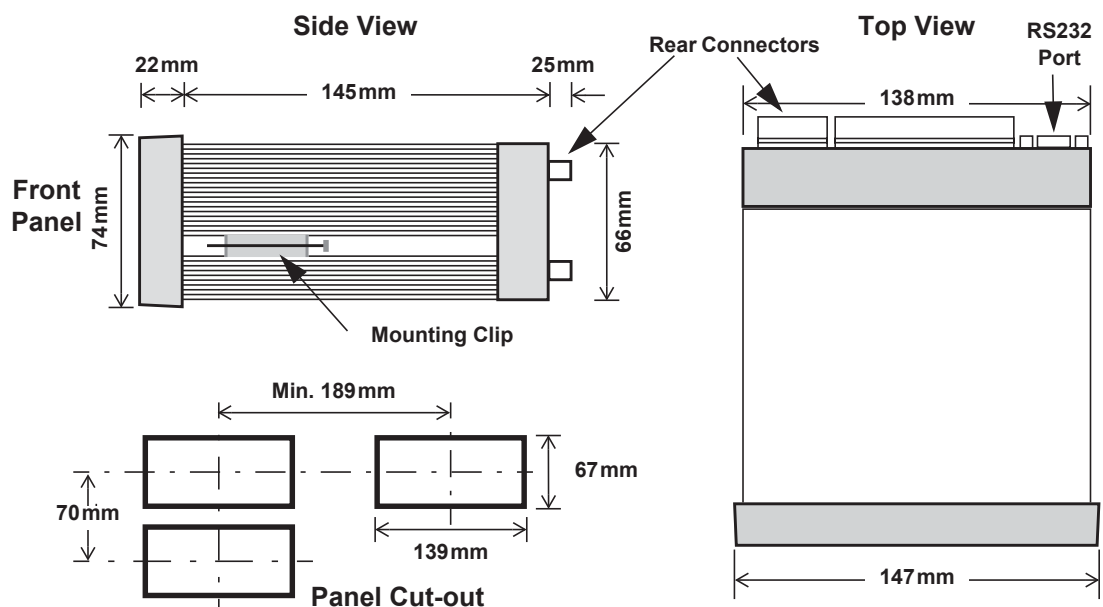

Figure 2 500 Series Instrument Panel Mounting

Electrical Connection

Rear Panel Connections



N.B. Depending on the specification and age of the instrument, there are different versions of the upper output card. Ensure the instrument is wired as per the correct terminal designation printed on the rear of the instrument bezel and below.

Figure 3 shows the connections on the rear panel of the instrument where relays 1 to 4 (terminals 32-35) share a single Relay Common (terminal 31).

N.B. The 5 way relay terminal block is GREEN.

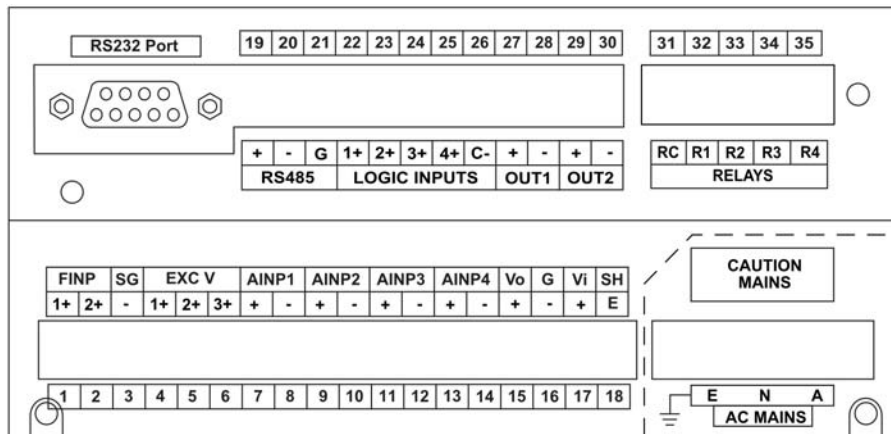

Figure 3 Rear Panel Connections - Original

Figure 4 shows the connections on the rear panel of the instrument where relays 1 and 2 (terminals 32-33) share Relay Common 1-2 (terminal 31) and relays 3 and 4 (terminals 34-35) share Relay Common 3-4 (terminal 36).

N.B. The 6 way relay terminal block is ORANGE.

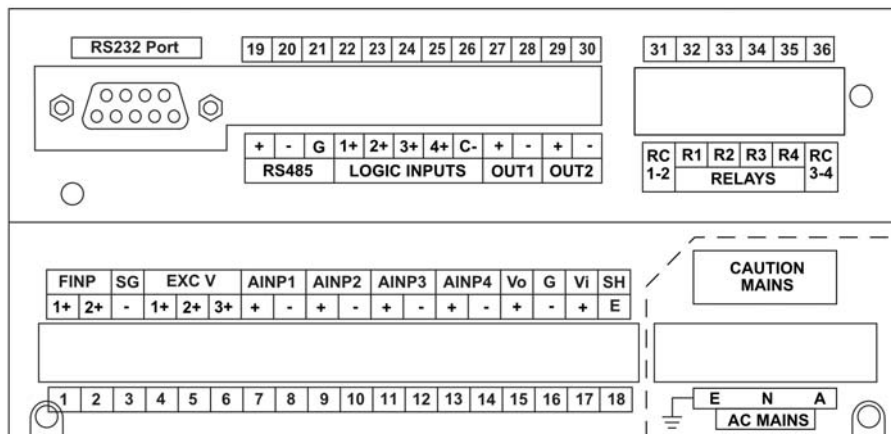

Figure 4 Rear Panel Connections - New RS485 Version

Figure 5 shows the new option card with the optional Ethernet port in place of RS-485 port (terminals 19-21).

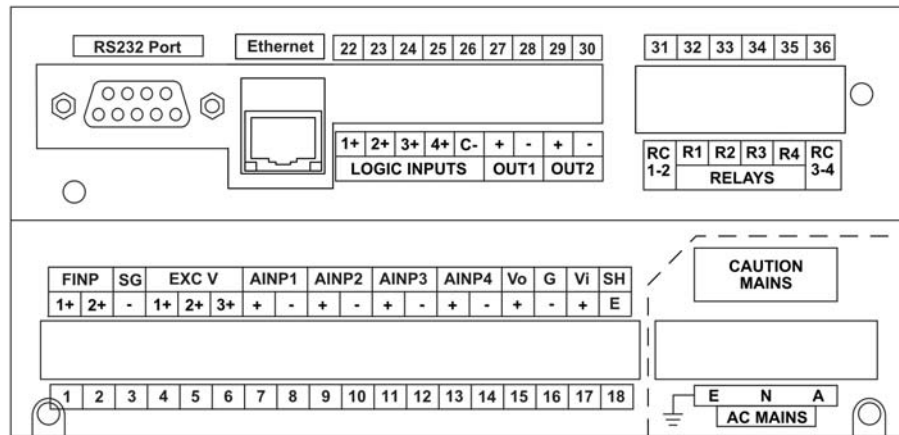

Figure 5 Rear Panel Connections - New Ethernet Version

Terminal Designations

Terminal Label	Designation	Comment	Terminal Label	Designation	Comment	
1	FINP 1+	Frequency Input 1+	Not used	19	RS485 +	RS485 (+)
2	FINP 2+	Frequency Input 2+	Not used	20	COM-2 -	RS485 (-)
3	SG -	Signal ground	Not used	21	G	RS485 ground
4	EXC V 1+	Excitation Term 1+	Not used	22	1+	Switch 1
5	EXC V 2+	Excitation Term 2+	For AINP1 RTD Input	23	2+	Switch 2
6	EXC V 3+	Excitation Term 3+	Not used	24	3+	Switch 3
7	AINP1 +	Analog Input ch 1 (+)	Temperature Input	25	4+	Switch 4
8	AINP1 -	Analog Input ch 1 (-)	Temperature Input	26	C-	Signal ground
9	AINP2 +	Analog Input ch 2 (+)	Pressure Input	27	+	Output ch 1 (+)
10	AINP2 -	Analog Input ch 2 (-)	Pressure Input	28	-	Output ch 1 (-)
11	AINP3 +	Analog Input ch 3 (+)	Main or Low Flow Input	29	+	Output ch 2 (+)
12	AINP3 -	Analog Input ch 3 (-)	Main or Low Flow Input	30	-	Output ch 2 (-)
13	AINP4 +	Analog Input ch 4 (+)	High Flow Stacked Input	31	RC	Relay Common 1-2
14	AINP4 -	Analog Input ch 4 (-)	High Flow Stacked Input	32	R1	Relay 1
15	Vo +	8-24 volts DC output	Overload protected	33	R2	Relay 2
16	G -	DC Ground	Overload protected	34	R3	Relay 3
17	Vi +	DC power input	DC power in 12-28V	35	R4	Relay 4
18	SH E	Shield terminal	DC power in 12-28V	36	RC	Relay common 3-4
E	AC MAINS E	Mains ground	AC power in 100-240VAC			
N	AC MAINS N	Mains neutral	AC power in 100-240VAC			
A	AC MAINS A	Mains active	AC power in 100-240VAC			
				RS232 COM-1 port		9-pin serial port

Terminal Wiring Insulation



Terminals 1-30 are all rated at <35Vdc and wiring with basic insulation is adequate.

Use copper conductors only.

Relay Wiring



Relay terminals are 31-35 or 31-36 depending on the version of option card fitted. When controlling circuits operate at mains voltages, or voltages >35Vdc, it is necessary to use UL/CSA approved cabling with supplementary insulation and a current capacity suitable for the connected circuit. Use copper conductors only. The maximum current must be <5A as stated in sec 2.

Where circuits >35Vdc are connected UL/CSA approved cabling with supplementary insulation. 0.75mm², 6A current capacity is sufficient.

Mains Power Wiring



Only use UL/CSA approved cabling with supplementary insulation and copper conductors. A minimum cable cross section area of 0.75mm² (18 AWG) is required. However, this must be selected with respect to the installed over-current protection device and in accordance with the local relevant Electrical Code of Practice as dictated by the Authority Having Jurisdiction (AHJ).

The terminal designations (L/N/E) are clearly indicated just above the mains input connector on the rear panel of the instrument.

Inputs

Analog Input Connections

All analog inputs can accept DC signals ranging from 0-5V, 1-5V and current signals from 4 to 20mA.

Analog Input 1 (AINP1) can also accept an RTD input (PT100 or PT500) as well as the standard 0-5V, 1-5V and 4 to 20mA input.

CAUTION

Applying levels of input current above the absolute maximum rating (100mA or 30mA for 4-20mA inputs) may cause permanent damage to the input circuitry.

0-5 and 1-5 Volt Inputs

For externally powered voltage transmitters, connect each transmitter to a pair of input terminals as shown in Figure 6. Refer to **Terminal Designations** on page 13 for specific terminal numbers for this application.

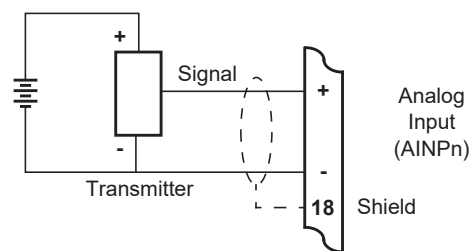

Figure 6 Externally Powered Voltage Transmitter

Connect internally powered voltage transmitters as shown in Figure 7.

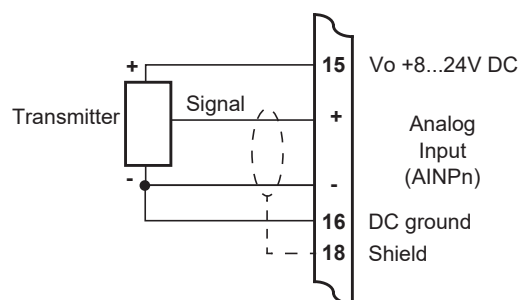

Figure 7 Internally Powered Voltage Transmitter

4-20 mA Inputs

For an externally powered current loop, connect the transmitter to the input terminals as shown in Figure 8. Refer to **Terminal Designations** on page 13 for specific terminal numbers for this application.

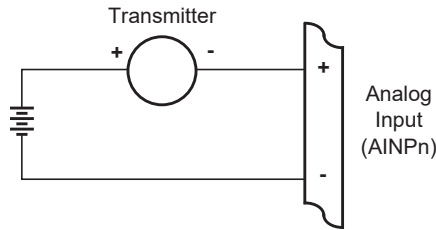
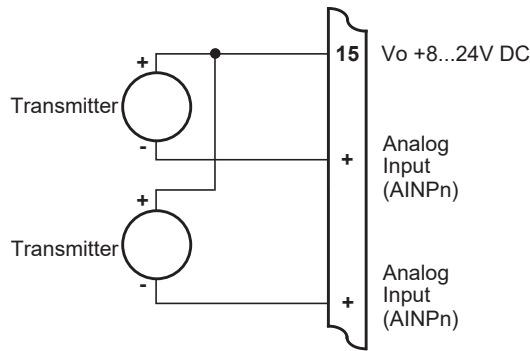

Figure 8 Externally Powered Current Loop

The internal overload-protected power supply has sufficient power for three current loops at 24 V DC (more current loops can be supplied by using a reduced voltage setting). Connect internally powered current loops as shown in Figure 9.

Figure 9 Internally Powered Current Loops



RTD Input

The instrument uses 4-wire RTDs to provide optimum accuracy and stability. It is not necessary to have equal cable lengths for the 4-wire RTDs, but they should be no longer than 50 metres. It is also recommended to use shielded twisted pairs.

Connect RTD inputs as shown in Figure 10.

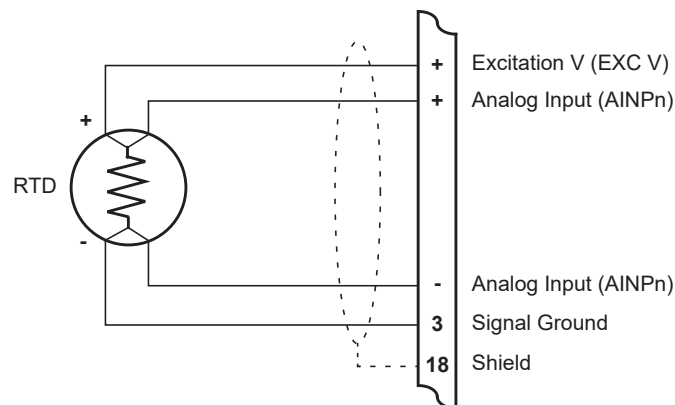

Figure 10 RTD Connection

Only Analog Input 1 (AINP1) is available for RTD connection.

Excitation terminal 2 (pin 5) must be used in conjunction with AINP1.

It is possible to use two-wire or three-wire RTDs. However, four wires must be taken to the RTD, with the signal and current wires joined as close to the RTD as possible.

Note: The RTD has no polarity and can be connected in either direction. However, the excitation and the positive analog input must be connected to one side of the RTD. Similarly, the Signal Ground and the negative analog input must be connected to the other side of the RTD.

Logic Input Connection

These input(s) are designed to be connected to CMOS, TTL, open collector signals or a voltage free contact switch. A minimum activation time of 300ms is required to guarantee reading of an input.

It is possible to read the status of all the logic inputs via a Modbus register even if they are not used for a control purpose in the application.

A remote push-button key can be connected to the Logic Inputs as shown below in Figure 11.

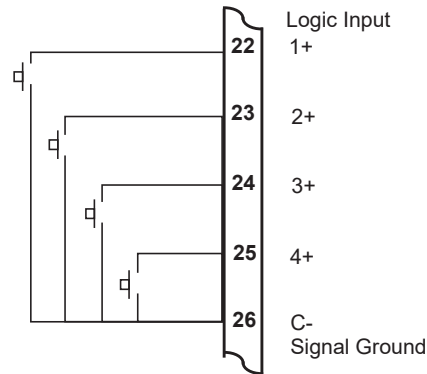

Figure 11 Logic Inputs Connection Diagram

Outputs

The advanced option for the instrument provides two opto-isolated output ports. Either or both can be used for 4-20mA or pulse outputs.

CAUTION

Due to the dual-purpose nature of the outputs, take care not to set the output as an open collector pulse type signal when connected to a 4-20mA loop circuit.

4-20mA Output Connection

Figure 12 shows the connections for a 4-20mA output. Output channel 1 uses terminals 27 (+) and 28 (-), output channel 2 uses terminals 29 (+) and 30 (-).

Maximum Load Resistance = (Supply-9) / 0.02 ohms

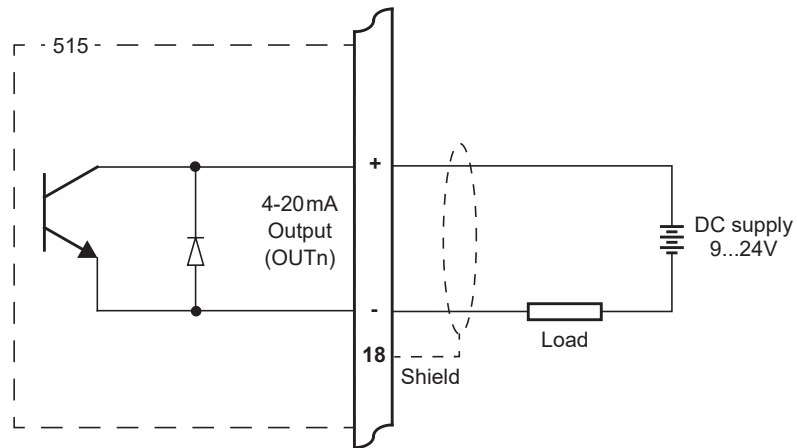

Figure 12 Output 4-20mA Connection Diagram

Pulse Output Connection

Figure 13 shows a connection example for a pulse output. Output channel 1 uses terminals 27 (+) and 28 (-). Output channel 2 uses terminals 29 (+) and 30 (-).

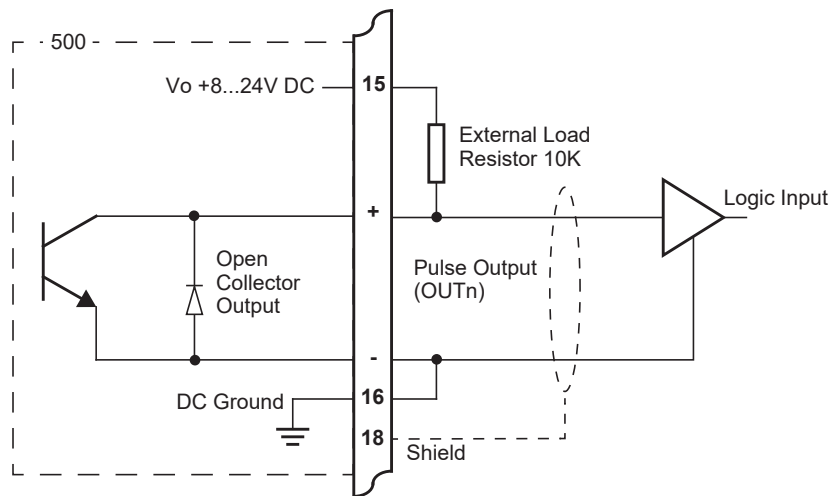

Figure 13 Output Pulse Connection Diagram

Control Relays (Alarms)

The standard instrument has two alarm relays, which can be used to drive external devices such as external relays, LEDs, and audible alarms. The advanced option has four alarm relays.

The operation of each alarm relay can be set to various modes as described in **Alarms** on page 48. On the newer option card the separate common terminal for relays 1 and 2 and another common terminal for relays 3 and 4 allow for different signal or supply types to be connected to the control or alarm devices, as shown in Figure 14.

There is also an equipment failure alarm option. This alarm can have normally closed (open) contacts which open (close) when the instrument displays any error message as listed in **Error Messages** on page 59, or if there is a loss of power to the instrument.

The output characteristics of the relays are:

- Maximum Voltage 30 volts DC or 250 volts AC
- Maximum Current 3 A for EMR, 1.5A for SSR

Note: Solid state relays (SSR) use AC voltage only.

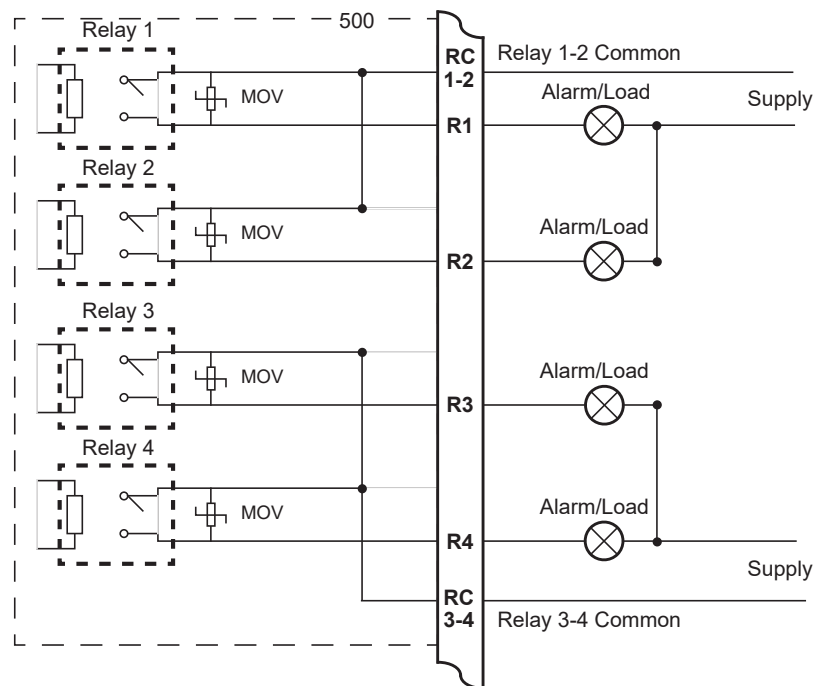

Figure 14 Relay Connection Diagram

RC Network for Interference Suppression

When driving inductive loads with the relay outputs, it is recommended to use RC suppression networks (often called “Snubbers”), fitted at the load end, for the following reasons:

- To limit the amount of electrical noise caused by arcing across the contacts, which may, in extreme cases, cause the microprocessor to act erratically or cause other unwanted interference with connected signals.
- To protect the relay contacts against premature wear through pitting or SSR (where specified) against premature failure.

RC suppression networks consist of a capacitor and series resistor and are commonly available in the electrical industry. The values of R and C are dependent entirely on the load. However, if the user is unsure of the type of snubber to use, values of 0.25 μF and 100 Ω will usually suffice. Note that only UL and mains approved RC suppression networks should be used.

The basic principle of the operation is that the capacitor prevents a series of sparks arcing across the contact as the contact breaks. The series resistor limits the current through the contact when the contact first makes.

Communications

The communication protocols are described in [Protocols](#) on page 65.

COM-1 RS-232 Port

The COM-1 RS-232 port has a 9-pin DB female connector and has the following pinout:

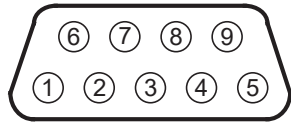

Pin 1	Not used
Pin 2	Transmit (TxD)
Pin 3	Receive (RxD)
Pin 4	Not used
Pin 5	Ground
Pin 6	Not used
Pin 7	Handshake line (CTS)
Pin 8	RTS Out
Pin 9	Not used

Note: The instrument does not require a null-modem cable for connection to a personal computer. Refer to [Hardware Interconnection](#) on page 63 for cable termination requirements.

COM-2 RS-485 Port Option

Up to 32 units can be connected to a common RS-485 bus. Each unit has a unique address that the host computer uses to identify each instrument. Figure 15 shows the connection of several instruments to a computer using the RS-485 port.

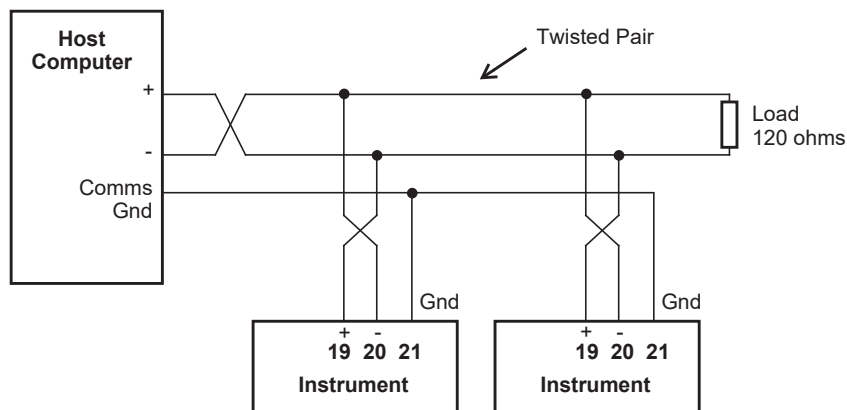

Figure 15 RS-485 Interface Connections

COM-2 Ethernet Port Option

An Ethernet module is an available option, in place of the RS-485 port, if Modbus TCP/IP connection is required. In the programming communication settings, COM-2 should be set to RTU (Modbus), 19200 Baud rate, even parity and 1 stop bit.

Mains Connection

Earthing and Shielding

A case earthing point is provided via the mains inlet. Note that this earthing point is for the case only and there is electrical isolation between this point and all electronic circuits. For EMC purposes, or when the instrument is connected to mains, this point must be connected to a good earth.

It is a good practice to use shielded cable for all signal connections to the instrument. Care must be taken to separate signal cables from power cables to minimize interference.

Overall earth should be connected at the instrument end only. This connection should be as short as possible and connected to the earthing point on the rear terminal at pin 18.

Disconnection Device

When powered from a mains supply this unit requires the provision of a suitable mains isolation device, capable of interrupting both poles of the supply and meeting your local wiring regulations, to be suitably located and easily accessible near to the installed instrument. It must be marked as the disconnecting device for the equipment. It must be suitably rated with respect to the cross sectional area of the supply conductors.

Maintenance Instructions

Occasionally it may be necessary to open the unit in order to change the Real Time Clock battery. No other service operations are permitted. In order to perform these operations and maintain safety it is essential to follow the instructions below. If mounted in an ExD enclosure, before proceeding, refer to the ExD manual for further information. This work may need to be scheduled and carried out in accordance with the local electrical Code of Practice.

Battery Replacement



INSTRUMENT MUST BE POWERED DOWN

1. Remove the top row of terminal blocks (19-36) Ethernet and RS232 cables if applicable.
2. Remove the two pan head machine screws on each side of the rear panel.
3. Withdraw the option card from the instrument.
4. Firmly press the battery holder tab to release the coin cell battery.
5. Identify the part number of the coin cell which is clearly marked on one side of the cell.
6. Firmly press the replacement coin cell into the holder
7. Reverse steps 1-3 for re assembly.

Battery Type



Only the battery type and manufacturer stated below should be used.

1. Instruments manufactured with issue 7 option card – CR2450N, Manufacturer RENATA ONLY*
2. Conformal coated “C” version - Type BR2032, manufacturer Panasonic ONLY.
3. Non Conformally coated versions :- BR2032, CR2032, Sony or Panasonic ONLY.

*Issue 7 option card can be identified with 6 way (31-36) ORANGE relay connector.

Chapter 4

Operation

Normal Operation

In normal operation mode, you press the buttons on the front panel to display the values recorded and calculated by the instrument. There are four categories of information that the instrument can display:

- Totals
- Rates
- Process variables
- Instrument settings

For each total, there is an associated rate as follows:

Total	Rate
Energy	Power
Volume	Volume Flowrate
Mass	Mass Flowrate

Default Total

In some applications, one set of variables is of more interest than others, and for this reason a default total and its associated rate can be assigned during instrument calibration. This default total can be used in two ways:

- The default variables come first in the sequence of totals and rates that are displayed with the front panel keys.
- If the display timeout option is enabled and no buttons are pressed for the selected period (usually 30 seconds) the display returns to the default total.

Status LEDs

The status LEDs illuminate to show the following conditions:



- Run** The host computer is downloading the application software.
- Set** The instrument is in Calibrate Set mode.
- Alarm** The instrument has an error, as indicated on the display panel.
- Cal** The instrument is in Calibrate View mode.

Front Panel Keys

For most actions with the front panel keys, you can hold a key to scroll through the values or options, instead of repeatedly pressing the key.

RATE Press the **RATE** key to display the rate that is associated with the currently displayed total. If an item other than a rate or total is displayed, press the **RATE** key to display the “default rate”. When a rate is displayed, press or hold the **RATE** key to display the other rate variables in turn.

TOTAL Press the **TOTAL** key to display the total that is associated with the currently displayed rate. If an item other than a rate or total is displayed, press the **TOTAL** key to display the “default total”. When a total is displayed, press or hold the **TOTAL** key to display the other total variables in turn.

RESET Use the **RESET** key to clear all resettable totals or to initiate a printout if the printer option has been selected. The printout is activated with a single press while the Total Reset function has different operation modes that are selectable during instrument calibration as follows:

- NONE - The user cannot reset the non-accumulated totals.
- INSTANT - When the user presses the **RESET** key, the instrument resets all non-accumulated totals.
- DELAYED - When the user holds the **RESET** key for two seconds, the instrument resets all non-accumulated totals.

The instrument makes three beeps when it resets the totals and two beeps when a printout is started.

DISPLAY Press the **DISPLAY** key to step or scroll through the main menu items.

ACCUM Hold the **ACCUM** key to display the accumulated value for the currently displayed total or to display the peak value for the currently displayed flowrate. See below for further details of peak flowrates.

Remote Reset

The Remote Reset on logic input 3 (Linp3) has the same function as the front **RESET** key, as described above.

Main Menu Items

The main menu in this instrument consists of the following items. The **DISPLAY** key is used to step or scroll through the list.

DISPLAY ↓	Description	Options
ENERGY	Energy content	Hold the ACCUM key to display accumulated total
POWER	Power (energy flowrate)	Hold the ACCUM key to display peak value
VOLUME	Volume	Hold the ACCUM key to display accumulated total
V-FLOW	Volume flowrate	Hold the ACCUM key to display peak value
MASS	Mass	Hold the ACCUM key to display accumulated total
M-FLOW	Mass flowrate	Hold the ACCUM key to display peak value
TEMP	Temperature	
PRESS	Upstream Pressure	Hold the SET key to view the absolute value if the type of pressure sensor is set to GAUGE.
SP-VOL	Steam specific volume	
SP-ENT	Steam specific enthalpy	
SE-ADJ	Specific enthalpy adjust	
SE-NET	Net specific enthalpy	
DIF-PR	Differential pressure	
Re-NUM	Reynolds number	
REPORT PRINT	Only shown in Detail Menu if a printer protocol is used	Hold the SET key to print log report as defined in the TM/LOG section of calibration.
LOGGED DATA	Only shown in Detail Menu if real-time clock option is installed	Hold the SET key to display data logs as described in Data Logs on page 28.
MODEL INFO	Only shown in Detail Menu	Hold the SET key to display the Model information as described in Model Information on page 30.
CAL MENU	Only shown in Detail Menu	Hold the SET key to enter Calibration View mode as described in Calibration View Mode on page 32.

Detail and Basic Menu

The 515 instrument has the option to switch the main menu from the full Detail menu to a Basic menu. The Detail menu includes all of the main menu variables and the HOLD SET sub menu items as listed above. In the Basic menu only the application or operator essential main menu variables are shown. The main menu variables to be shown in the basic menu need to be selected in the 500 Series Program Manager (500-PM Software) prior to the application software being downloaded to the instrument. The 500-PM Software is Windows based configuration and resource tool for the 500 Series and is freely available from the www.contrec.co.uk website.

To switch between the Detail and Basic menu, while in the main menu, press and hold the **DISPLAY** and **SET** keys together for 5 seconds. When switching to the Detail menu the display will briefly show:

d I S P L A Y DETAIL MENU.

When switching to the Basic menu the display will briefly show:

d I S P L A Y BASIC MENU.

When the application software is first installed, the default is the Detail menu. From that point, the menu type is saved and restored on power cycle. The menu type will need to be Detail to access the **CALL MENU**

Peak Flowrates

The peak value for the currently displayed flowrate can be viewed by holding the **ACCUM** key. The peak value is the average over a 15 minute period since the last reset of totals or powering on of the instrument. Dashes are shown for this value after a reset or power on until the first averaging period has passed.

Data Logs

The instrument will log the main-menu variables if real-time clock option is installed. The logs are at fixed intervals of hours, days, weeks, months and years. The instrument can store a total of more than 1000 log entries.

If the number of log entries exceeds the programmed number for a particular time interval, the oldest log entry is overwritten by the newest one for that time interval.

Also note that the totals are saved as accumulated totals.

The log entries are recorded at the following times:

- HOUR 00 minutes each hour
- DAY 00 hours and 00 minutes each day
- WEEK 00 hours and 00 minutes each Monday
- MONTH 00 hours and 00 minutes on the first day of the month
- YEAR 00 hours and 00 minutes on the first day of the year.

View Data Logs

Use the following procedure to view the data that has been logged by the instrument:

1. Press the **DISPLAY** key to scroll through the menu to the **LOGGED DATA** prompt.
2. Hold the **SET** key.

The system displays the hourly log. The timebase and number of the log are shown, for example LH-001.

3. While holding the **DISPLAY** key use the **RESET** key to print the data for the displayed log if the printer option has been selected.

The following example shows the hourly log number 006 at 15:00 (3:00 pm) on 16 January 2019. The day and month alternate with the year in the bottom right hand corner.



Figure 16 shows how to display the logged data.

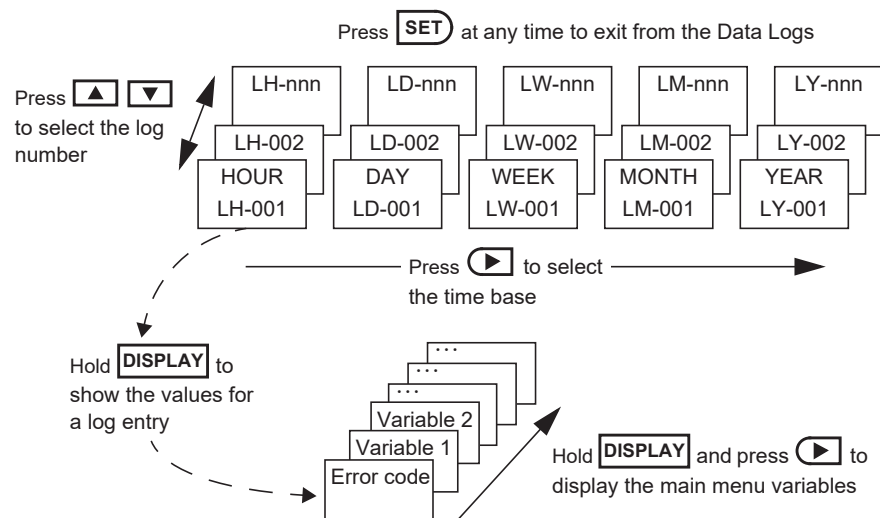

Figure 16 Logged Data Display Methods

Model Information

The model information items display the hardware, software and application versions of the instrument. This information is mainly for service personnel.

<div style="border: 1px solid black; padding: 2px; display: inline-block;">DISPLAY</div> ↓	Description
2-1-5- 515 MODEL	The hardware model code. Refer to Product Codes on page 85 for more information.
- - tPLH SC04 INPUT	The Application number and the assignment of the inputs. Refer to Application Information Code on page 86 for more information.
3.0.000 500-PM VERS	The version of 500-Series Program Manager from which the application software was compiled.
026357 CUSTOM VERS	The Customer version code for this installation. Refer to Custom Version Codes on page 86 for more information.
123456 ABC123 S/N	The instrument serial number and unit tag. The serial number is on the top line and unit tag is on the bottom left. Both items are entered when the instrument application software is initially loaded. If the unit tag is not used the default tag, UNIT, will be used.
16-15 EDITED 27/08 2019	The time and date when the calibration of the instrument was last edited. The format of the time and date is the same as for the data logs. This example shows 16:15 (4:15pm) on the 27th August 2019. This function is available only if the instrument has the real time clock option.
CLASS-3 FLASH V-019	The instrument Class and Flash (bootloader) version.
5 POWER CYCLE	The number of power cycles that have occurred since the application software was installed.
1 WDT RESET	The number of 'watchdog timer' (WDT) resets that have occurred since the application software was installed. The WDT Reset count is only shown if a WDT Reset has occurred.
HOLD RESET CONFIG PRINT	If the printer protocol is assigned to one of the communication ports, the prompt to print the full program configuration report will be shown. Hold Reset to start the printing of the configuration report. The report will be in a similar format to the report generated by the 500 Program Manager.

Press SET at any time to exit from the Model information.

Chapter 5

Instrument Calibration

Introduction

The 500 Series instrument calibration settings can be programmed via the front panel, according to program access levels explained below, or via the 500 Series Program Manager - a freely available Windows based configuration and resource tool.

After an instrument has been configured by either means to suit the application requirements, the settings can be recorded or application software backups or instrument clones created as explained further in [Program Backup & Reports](#) on page 35.

You can view or change the settings of the instrument according to the access level for each parameter, as set by the 500 Series Program Manager. There are five levels of access to the parameters as follows:

- **Not visible** - you cannot display or edit the parameter.
- **Display only** - you can display the parameter, but you cannot change the setting.
- **Programmable** - you can change the setting of the parameter in Calibration Set mode.
- **Password protected** - you can change the setting of the parameter in Calibration Set mode only if you enter the correct password.
- **CAL switch protected** - you can change the setting of the parameter in Calibration Set mode only if you enter by using the CAL switch on Logic Input 4 to accept the password.

Note: When you enter Calibration Set mode, the instrument prompts to enter a password. Any value will allow to change the settings of the “programmable” parameters, but the correct password must be entered to change the password-protected parameters. Likewise, the CAL switch (Logic Input 4) must be used to accept the password to change the CAL switch protected parameters.

Calibration View Mode

Use the following procedure to view the calibration settings of the instrument:



1. Press **DISPLAY** to scroll to the **CAL MENU** prompt.
2. Hold the **SET** key.

The instrument beeps once, illuminates the **Cal** indicator and shows **CAL** on the display panel.

- Press **▶** to scroll through the flashing menu headings.
- Press **SET** to scroll through submenu items.
- Hold **DISPLAY** to return to the main calibration menu.

3. To exit from the Calibration View mode, press **▶** to scroll to the **END** option and press **SET**.

The instrument returns to Normal Operation mode.

Calibration Set Mode

In Calibration Set mode, you can change the settings of the “programmable” parameters. You must enter the system password to change the setting of the “password-protected” parameters and you must use the CAL switch on Logic Input 4 to access the “Cal switch protected” parameters.

Use the following procedure to enter Calibration Set mode:

1. Press **DISPLAY** to scroll to the **CAL MENU** prompt.
2. Hold the **SET** key.



The instrument beeps once, illuminates the **Cal** indicator and shows **CAL** on the display panel.

3. Press **▶** to select any flashing menu heading except **END**.
4. Hold the **SET** key for two seconds, or if “Cal switch protected” items exist the CAL switch can be closed for two seconds.

The instrument prompts for a password to be entered if the password is non-zero, otherwise the password prompt is skipped.

5. If the password prompt is shown, press **▲** or **▼** to change the value of the current digit. To select the next digit, press **▶**.
6. Press **SET** or use the CAL switch on Logic Input 4 (if “Cal switch protected” items exist) to accept the password and proceed.

7. Proceed and observe the access confirmations.
 - If the CAL switch is used and the password is correct, the instrument makes two beeps and displays message:
`- Edit - CS_PW MODE`
 and enables you to change “programmable”, “password protected” and “CAL switch protected” parameters.
 - If the CAL switch is used but the password has been skipped or is incorrect, the instrument makes one beep and displays message:
`- Edit - CAL_SW MODE`
 and enables you to change “programmable” and “CAL switch protected” parameters.
 - If the **SET** key is pressed and the password is correct the instrument makes two beeps and displays the message:
`- Edit - PASSW MODE`
 and enables you to change the “programmable” and “password-protected” parameters.
 - If the **SET** key is pressed but the password has been skipped or is incorrect, the instrument makes one beep and displays the message:
`- Edit - PROG MODE`
 and enables you to change only the “programmable” parameters.



The instrument illuminates both the **Cal** and **Set** indicators.

8. Edit the instrument parameters as required. The programmable values are indicated by the flashing display.
 - To change a numerical value, press **▲** to increase a value, or press **▼** to decrease a value. Press a key momentarily to change the value one number at a time. Hold a key to scroll through the numbers. To proceed to next digit, press **▶**.
 - To change an option setting, press **▲** or **▼** to scroll through the options.
9. Press **SET** to accept the currently displayed value and proceed to the next parameter. You can press **DISPLAY** to briefly view the current edit mode:
`- Edit - XXXXXX MODE`, as described in step 6 above.
 Continue to hold the **DISPLAY** key to return to the main calibration menu.
10. To exit from Calibrate Set mode, press **▶** to scroll through the main calibration menu to **END**, then press **SET**. Otherwise, to quick exit from any menu, you can press and hold **SET** for two seconds or, if “Cal switch protected” items exist, the CAL switch can be closed for two seconds.



The instrument makes two beeps and cancels the **Cal** and **Set** indicators.

Changing the Instrument Settings

In Calibration Set mode, the display flashes the item that can be changed. For option settings, the display flashes the complete option. For a numeric parameter, the display flashes one digit at a time, you can change the value of the flashing digit as required, then move the flashing cursor to change another digit.

Note: When you change the setting of a parameter, the instrument records the result as soon as you move to another parameter, or exit from the Calibration Set mode.

Changing Option Settings

When you display an option that can be changed, the entire option flashes on the display, such as the choices of ODD, EVEN or NONE for the communications parity bit checking. Press or to change the option. You can “scroll” through the options in either direction to make a selection as shown below.

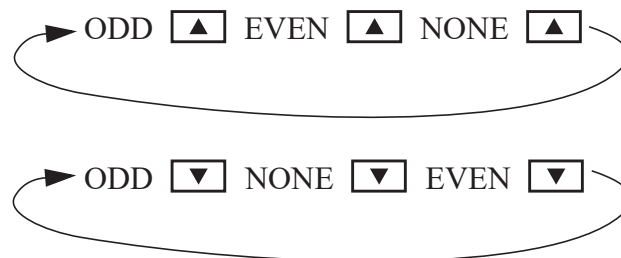

Changing Numeric Settings

The display flashes the digit that can be changed.



Press to select the digit that you wish to change.

Press or to increase or decrease the value of the selected digit.

Changing the Decimal Point

To change the position of the decimal point, press to move the flashing selection until the decimal point flashes. Press or to move the decimal point to the right or left as required.

Units of Measurement

The calibration of some parameters is based on the units that are defined for the relevant variables. These units of measurement can be viewed in the UNITS menu in the Instrument Settings section below.

Program Backup & Reports

Backup via 500 Series Program Manager

As well as programming the 500 Series instruments via the front panel (according to program access levels), the 500 Series Program Manager (500-PM) can be used to create a custom version of the application software and program parameters preset prior to downloading the application software. Backups of customised applications can be saved as download-able APX or APL files and the full configuration reports printed or saved as PDF. The 500-PM is a Windows based programming tool and resource centre and is freely available from the Contrec www.contrec.co.uk website.

Instruments are often supplied from the factory with the default application software, but it is by using 500-PM software that program access levels are set, USER text and messages customised and print headers and footers entered.

Printing Configuration Report

To assist in keeping an audit trail of the program settings and changes made via the front panel, the 515 instrument provides the ability to print the configuration to a local printer if one has been connected and assigned to one of the 515 communication ports.

The prompt to hold the Reset key to print the configuration report

HOLD RESET CONFIG PRINT

is found at the end of the Model Info menu, described in **Model Information** on page 30. The report can be lengthy and adequate printer paper must be available (Note: This feature is available starting from version 3.0.377).

Upload and Clone of Application Software

To assist in maintaining a backup for important applications and installations, the 500-Series Program Utility software (500-LT, version 3.0.377 or higher) can be used to upload the instruments application software with all of the current program settings.

The 500-LT (PM Lite) program is a Windows based computer program which can be downloaded for free from the Contrec www.contrec.co.uk website and is part of the package when the Contrec 500 Series Program Manager is installed. The 500-LT provides the option to 'Upload Application' or 'Upload Report Only'. To use either upload functionality, the 515 port being used must have printer (PRN) protocol assigned to it.

Once uploaded to the 500-LT, the report can be viewed or printed. The Upload Application is automatically saved as an APL file. The file can be used then or reopened later to download to another 515 instrument (of the same or higher class) to create a clone of the original instrument.

Calibration Menu Tree

Figure 17 and Figure 18 show the keys for moving around the calibration menu tree in Calibration View or Set mode.

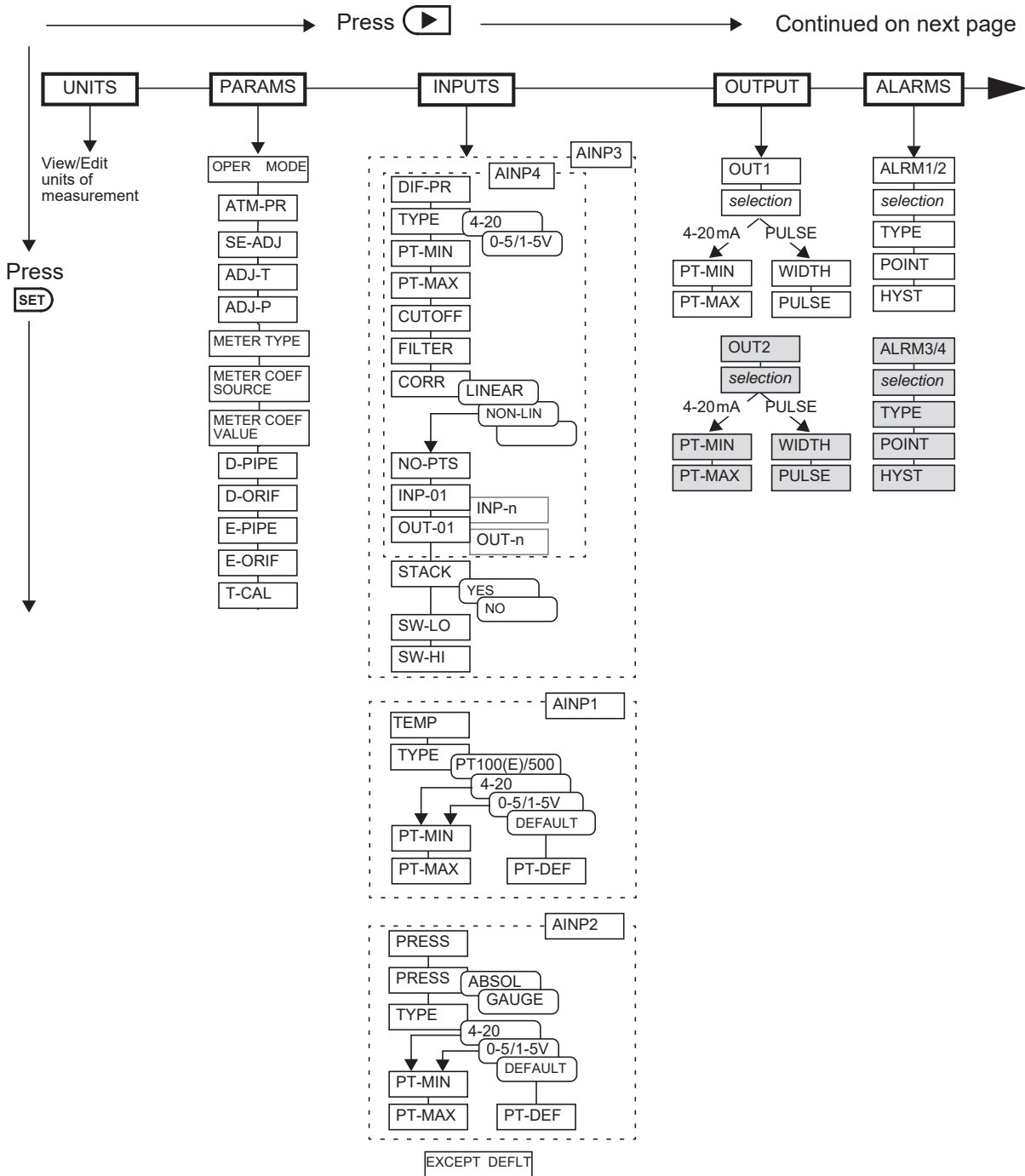
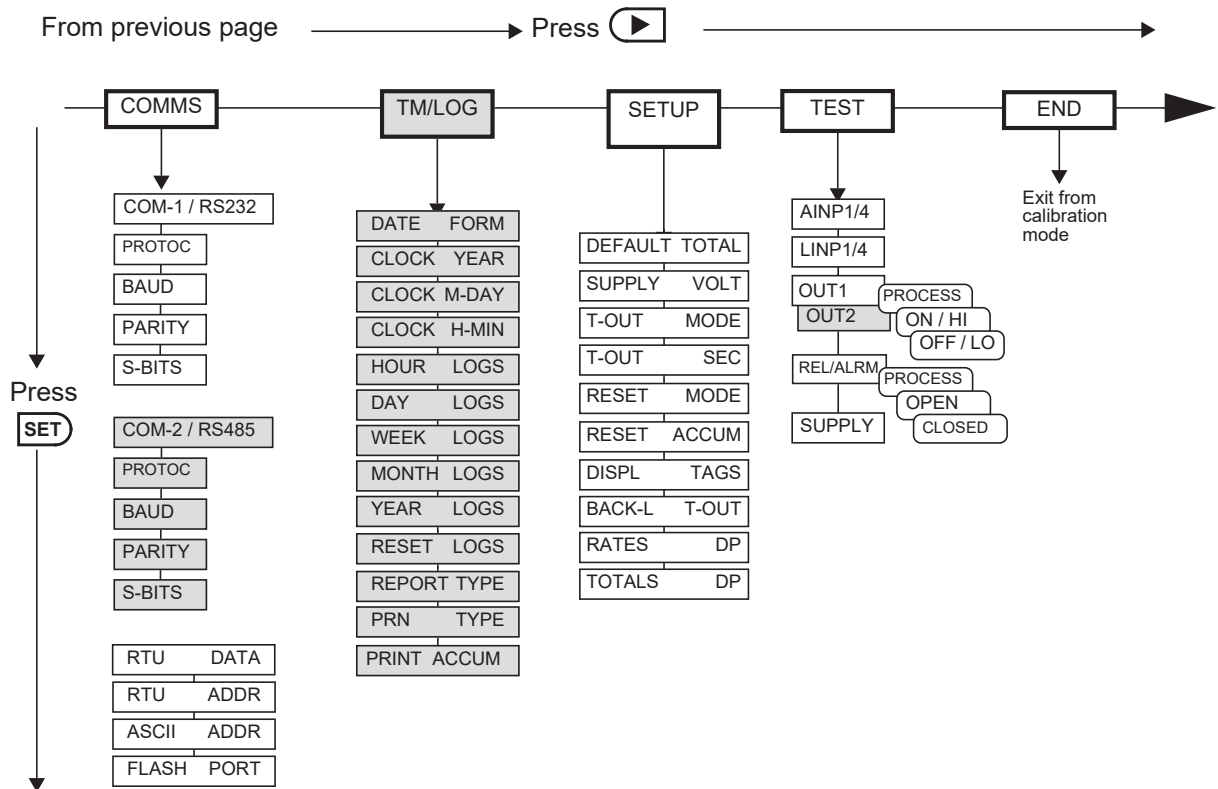

Figure 17 Calibration Menu Tree Sheet 1



 The shaded boxes indicate hardware options

Hold **DISPLAY** at any point to return to the main calibration menu.











Press  at any I/O assignment position to move to the next I/O assignment in the submenu (eg pressing  on ALRM1 will move you to ALRM2 if it exists)

Figure 18 Calibration Menu Tree Sheet 2

Instrument Settings

Units of Measurement

The Units menu allows the units to be viewed and edited, if accessibility has previously been selected/enabled, without the reloading of new application software. Any change in units will result in a full reset to initially downloaded settings. Therefore, any required changes to units of measurement should be made before changing any other settings.

 ↓	 → UNITS PARAMS INPUTS OUTPUTS ALARMS COMMS TM/LOG SETUP TEST END
ITEM <i>n</i> <i>unit</i>	<p>The units for main menu or calibration items can be viewed by pressing the  key.</p> <p>The units of measurement are password protected or will be protected by the CAL switch if any instrument setting has an access level of ‘CAL Switch Protected’. To edit the units the correct password must be entered or CAL switch used on entry to EDIT mode.</p> <p>Press  or  to select the required units.</p>
ACCEPT UNITS	<p>The Accept Units prompt will only appear if one or more of the units have been changed.</p> <p>IMPORTANT: Accepting the change of units will initiate a master reset. All calibration parameters will revert to their default value (i.e. those values included in the downloaded instrument software). All totals and any logged information will be cleared.</p> <p>Press  or  to select YES, then press the  key. The instrument makes three beeps to confirm the reset command.</p> <p>The message -RESET- PLEASE WAIT will be displayed as the instrument exits calibration mode and completes a full re-boot sequence.</p>

Parameters





SET ↓	▶ → UNITS PARAMS INPUTS OUTPUTS ALARMS COMMS TM/LOG SETUP TEST END
OPER MODE	<p>The operation mode allows an instrument to be configured for saturated/superheated steam or water applications.</p> <ul style="list-style-type: none"> • SAT-T - Saturated steam with temperature input • SAT-P - Saturated steam with pressure input • SUPER-1 - Superheated steam (standard) • SUPER-2 - Superheated steam (uses default temperature and pressure when outside the superheated region) • SUPER-3 - Superheated steam (uses saturated steam curve and pressure input when outside the superheated region) • LIQUID - Liquid water, applications such as boiler feed or condensate return measurement <p>Select the operation mode as required.</p> <p>Press <input type="button" value="▲"/> or <input type="button" value="▼"/> to select one of the options.</p>
ATM-PR unit	<p>If the pressure sensor is configured as a Gauge type sensor, the instrument adds the atmospheric pressure to the measured pressure to determine the absolute pressure. Set the atmospheric pressure (absolute) according to the height above sea level.</p>
SE-ADJ OPT	<p>The specific enthalpy adjustment option allows any initial energy to be offset, by deducting the specific enthalpy adjustment value (calculated from entered reference conditions) from the specific enthalpy at flowing/measured conditions. If enabled the resultant net specific enthalpy is then used to calculate the power and energy.</p> <p>For more details on each calculation type refer to Specific Enthalpy & Energy Offset on page 2</p> <p>Press <input type="button" value="▲"/> or <input type="button" value="▼"/> to select ENABLE or DISABLE.</p>
ADJ-T unit	<p>Enter the specific enthalpy adjustment reference temperature at which the adjustment value is calculated.</p>
ADJ-P unit	<p>Enter the specific enthalpy adjustment reference pressure (absolute) at which the adjustment value is calculated.</p>

SET ↓		▶ → UNITS PARAMS INPUTS OUTPUTS ALARMS COMMS TM/LOG SETUP TEST END												
METER	TYPE	<p>Enter the type of differential pressure flowmeter from the available list, including those in accordance with ISO 5167.</p> <p>Press ▲ or ▼ to select the type of meter as follows:</p> <table style="width: 100%; border: none;"> <tr> <td style="width: 50%;">ISO-01 Orifice plate with corner tapping</td> <td style="width: 50%;">ISO-07 Venturi tube ‘machined’</td> </tr> <tr> <td>ISO-02 Orifice plate with D-D2 tapping</td> <td>ISO-08 Venturi tube ‘welded’</td> </tr> <tr> <td>ISO-03 Orifice plate with flange tapping</td> <td>ISO-09 Venturi nozzle</td> </tr> <tr> <td>ISO-04 Nozzle to ISA 1932</td> <td>CONE-01 McCrometer: V-Cone</td> </tr> <tr> <td>ISO-05 Nozzle ‘long radius’</td> <td>CONE-02 McCrometer: Wafer-Cone</td> </tr> <tr> <td>ISO-06 Venturi tube ‘as cast’</td> <td></td> </tr> </table>	ISO-01 Orifice plate with corner tapping	ISO-07 Venturi tube ‘machined’	ISO-02 Orifice plate with D-D2 tapping	ISO-08 Venturi tube ‘welded’	ISO-03 Orifice plate with flange tapping	ISO-09 Venturi nozzle	ISO-04 Nozzle to ISA 1932	CONE-01 McCrometer: V-Cone	ISO-05 Nozzle ‘long radius’	CONE-02 McCrometer: Wafer-Cone	ISO-06 Venturi tube ‘as cast’	
ISO-01 Orifice plate with corner tapping	ISO-07 Venturi tube ‘machined’													
ISO-02 Orifice plate with D-D2 tapping	ISO-08 Venturi tube ‘welded’													
ISO-03 Orifice plate with flange tapping	ISO-09 Venturi nozzle													
ISO-04 Nozzle to ISA 1932	CONE-01 McCrometer: V-Cone													
ISO-05 Nozzle ‘long radius’	CONE-02 McCrometer: Wafer-Cone													
ISO-06 Venturi tube ‘as cast’														
METER	COEF source	<p><i>This parameter is available for viewing and editing only when the meter type is set to one of the “ISO” flowmeters.</i></p> <p>Select the DP Meter Coefficient Source. The differential pressure flowmeter discharge coefficient can be calculated in accordance with the ISO standard or manually entered as a constant by the user.</p> <p>Press ▲ or ▼ to select ISO-STD or USER.</p>												
METER	COEF value	<p>This parameter is only available and used as the constant for the flowmeter discharge coefficient for cone type meters or when a “USER” value is preferred to the ISO standard calculations.</p> <p>Enter the differential pressure flowmeter coefficient (0.000 to 1.999).</p>												
I-PIPE	unit	Enter the internal diameter of the pipe at the calibration temperature.												
I-ORIF	unit	<p>Enter the diameter of the orifice at the calibration temperature. If the meter is of a “cone” type, enter the cone diameter.</p> <p>If the <i>diameter ratio</i> (β) is given instead of the <i>orifice (or cone) diameter</i> (d), it can be calculated from the <i>pipe diameter</i> (D) as:</p> $d = D \times \beta$ <p style="text-align: center;">or</p> $d = D \sqrt{1 - \beta^2} \quad \text{(for cone type meters).}$												
E-PIPE	unit	Enter the thermal expansion coefficient of the pipe material. If correction for thermal expansion is not required, set the coefficient to 0.0. Some sample values are shown in Properties of Commonly Used Materials on page 90.												

SET ↓	▶ → UNITS PARAMS INPUTS OUTPUTS ALARMS COMMS TM/LOG SETUP TEST END
E-ORIF <i>unit</i>	Enter the thermal expansion coefficient of the orifice device material. If correction for thermal expansion is not required, set the coefficient to 0.0. Some sample values are shown in Properties of Commonly Used Materials on page 90.
T-CAL <i>unit</i>	Enter the calibration temperature at which the pipe and orifice diameters have been determined. If thermal expansion correction is not required, such as when E-PIPE and E-ORIF are set to zero, the system ignores this setting.

Inputs

SET ↓	▶ → UNITS PARAMS INPUTS OUTPUTS ALARMS COMMS TM/LOG SETUP TEST END
Analog Input 3 and optional Analog Input 4 for stacked differential pressure meters	
INPUT DIF-PR AINP3 AINP4	For this application, Analog Input 3 is assigned to differential pressure main input (if not stacked) or low range input if stacked with Analog Input 4.
TYPE AINP3 AINP4	Select the type of analog input source. Press <input type="button" value="▲"/> or <input type="button" value="▼"/> to select 0-5V, 1-5V or 4-20mA.
PT-MIN AINP3 PT-MAX AINP4	Enter the value of the measured parameter (in the assigned engineering units) that corresponds to the minimum input signal level. The minimum point is commonly set at a base flowrate of 0.0. Enter the value of the measured parameter (in the assigned engineering units) that corresponds to the maximum input signal level. The maximum point is the same as the base value (set at the minimum point) plus the span value. For example, if the source signal is 4mA at a minimum differential pressure of 0kPa, enter 0 as the minimum point. If the source signal is 20mA at a maximum differential pressure of 200kPa, enter 200 as the maximum point.
CUTOFF AINP3 AINP4	The Cut-off is the lowest value that the instrument reads from the input sensor. The cut-off setting is the percentage of the span of the input values. All inputs at or below the cut-off value are considered negligible to the instrument and are ignored. In this case, the instrument uses the minimum value (set at PT-MIN).

 ↓	 → UNITS PARAMS INPUTS OUTPUTS ALARMS COMMS TM/LOG SETUP TEST END		
FILTER RINP3 RINP4	<p>Input fluctuations caused by pulsating flow tend to create distortion in the input readings of the rate. The instrument has a digital filter that averages out these fluctuations.</p> <p>As a guide to the degree of filtering to use, the following table shows the response time (in seconds) to reach 90% and 99% of a step change in input.</p> <p>The value A is the filter constant that the user can set.</p>		
	Filter setting A	Seconds to reach 90% of full swing	Seconds to reach 99% of full swing
	0	0	0
	2	2	4
	4	4	8
	6	5	10
	10	8	15
	15	12	23
	20	14	27
	25	18	34
	35	25	48
	45	32	62
	60	42	82
	75	52	102
	90	62	122
	99	68	134
	<p>The input filter range is from 0 to 99. A setting of 0 (zero) means that there is no filtering.</p>		
CORR RINP3 RINP4	<p>Analog input non-linearity can be corrected as follows:</p> <ul style="list-style-type: none"> • LINEAR • NON-LINEAR to use the following linearity correction parameters <p>Use  or  to select LINEAR or NON-LINEAR.</p>		

<div style="border: 1px solid black; padding: 2px; display: inline-block;">SET</div> ↓	<div style="border: 1px solid black; padding: 2px; display: inline-block;">▶</div> → UNITS PARAMS INPUTS OUTPUTS ALARMS COMMS TM/LOG SETUP TEST END
NO-PTS RINP3 RINP4	<p><i>This parameter is available for viewing and editing only when the correction type is set to Non-linear.</i></p> <p>Enter the number of non-linearity correction points.</p> <p>Press ▲ or ▼ to select a number between 1 and 20 for the number of correction points.</p>
INP--01 RINP3 to RINP4 INP--n	<p><i>This parameter is available for viewing and editing only when the correction type is set to Non-linear.</i></p> <p>Enter the normalised input value for the correction point.</p> <p>The instrument uses linear interpolation between the correction points. An input and an output value are entered for each correction point. The values are normalised between the minimum point (0.0) and the maximum point (1.0). Only the points between 0 and 1 are required to be entered and should be entered in ascending order.</p> <p>The following diagram shows a 5 point linearised representation of the input for a hypothetical flowmeter. The heavy black line represents the actual input from the flowmeter. The light black line is the approximation that the instrument uses.</p> <div style="text-align: center;"> </div> <p>You can hold the DISPLAY key to skip the non-linear points and go to the next item.</p>
OUT--01 RINP3 to RINP4 OUT--n	<p><i>This parameter is available for viewing and editing only when the correction type is set to Non-linear.</i></p> <p>Enter the normalised output value for the correction point.</p>

SET ↓	▶ → UNITS PARAMS INPUTS OUTPUTS ALARMS COMMS TM/LOG SETUP TEST END
STACK AINP3	<p>Select YES to stack AINP3 as the low range input with AINP4 as the high range input.</p> <p>Select NO to use AINP3 as the only flow input.</p>
SW-LO AINP3 SW-HI	<p><i>These parameters are available for viewing and editing only when the Stack option is set to Yes.</i></p> <p>Stacked DP switching is based on the low-range input (AINP3). When the input is less than the SW-LO value, the instrument switches to the low-range input (AINP3). When the input is greater than the SW-HI value, the instrument switches to the high-range input (AINP4).</p> <p>The switch settings are percentages of the span of the unadjusted input to AINP3. For example, with a 4-20mA input, a setting of 90% is 18.4mA and 95% is 19.2mA.</p> $\frac{(20 - 4) \times 90}{100} + 4 = 18.4 \qquad \frac{(20 - 4) \times 95}{100} + 4 = 19.2$ <p>Enter SW-LO and SW-HI values as 0 to 99%. SW-HI should be set sufficiently higher than SW-LO to avoid rapid toggling between the two inputs.</p>
Analog Input 1 - not available when Operation Mode is set to SAT-P	
INPUT TEMP AINP1	For this application, Analog Input Channel 1 is assigned to Temperature.
TYPE AINP1	<p>Select the type of analog input source.</p> <p>Press <input type="button" value="▲"/> or <input type="button" value="▼"/> to select 0-5V, 1-5V, 4-20mA, PT100, PT100-E, PT500 or DEFAULT.</p> <p>Note: PT100-E allows for extended temperature range (-200 to 800°C).</p>
PT-DEF AINP1	<p>The Default Point is a fixed value that the instrument uses when the Input Type is set to DEFAULT or Default Value On Exception has been chosen. You can use the Default value instead of a sensor signal for testing purposes, or if the sensor is faulty.</p> <p>You can set the Default value during instrument commissioning so that it is available immediately if you select the Default input type at a later date.</p> <p>Enter the value in the engineering units of assigned variable.</p>

SET ↓	▶ → UNITS PARAMS INPUTS OUTPUTS ALARMS COMMS TM/LOG SETUP TEST END
PT--MIN AINP1 PT--MAX	<p><i>The Minimum Point and Maximum Point parameters are only for 0-5V, 1-5V and 4-20mA inputs.</i></p> <p>Enter the value of the measured parameter that corresponds to the minimum input signal level. The minimum point is commonly referred to as the base value.</p> <p>Enter the value of the measured parameter that corresponds to the maximum input signal level. The maximum point is the same as the base value (set at the minimum point) plus the span value.</p> <p>For example, if the source signal is 4mA for a temperature of 10°C, enter 10 for the minimum point. If the source signal is 20mA for a temperature of 2000°C, enter 2000 as the maximum point.</p>
Analog Input 2 - not available when Operation Mode is set to SAT-T	
INPUT PRESS AINP2	For this application, Analog Input Channel 2 is assigned to Pressure.
PRESS AINP2	<p>Select the type of analog pressure sensor. For a gauge type sensor, the instrument adds the atmospheric pressure as defined in the Parameters menu.</p> <p>The pressure will be displayed as absolute or gauge, whichever is selected and indicated with an 'A' or 'G' at the end of the pressure units. However the pressure value when logged or read via serial communications will always be absolute.</p> <p>Press <input type="button" value="▲"/> or <input type="button" value="▼"/> to select ABSOL or GAUGE.</p>
TYPE AINP2	<p>Select the type of analog input source.</p> <p>Press <input type="button" value="▲"/> or <input type="button" value="▼"/> to select 0-5V, 1-5V, 4-20mA or DEFAULT.</p>
PT--DEF AINP2	<p>The Default Point is a fixed value that the instrument uses when the Input Type is set to DEFAULT or Default Value On Exception has been chosen. You can use the Default value instead of a sensor signal for testing purposes, or if the sensor is faulty.</p> <p>You can set the Default value during instrument commissioning so that it is available immediately if you select the Default input type at a later date.</p> <p>Enter the value in the engineering units of assigned variable.</p>

<input type="button" value="SET"/> ↓	<input type="button" value="▶"/> → UNITS PARAMS INPUTS OUTPUTS ALARMS COMMS TM/LOG SETUP TEST END
PT-MIN AINP2 PT-MAX	<p><i>The Minimum Point and Maximum Point parameters are only for 0-5V, 1-5V and 4-20mA inputs.</i></p> <p>Enter the value of the measured parameter that corresponds to the minimum input signal level. The minimum point is commonly referred to as the base value.</p> <p>Enter the value of the measured parameter that corresponds to the maximum input signal level. The maximum point is the same as the base value (set at the minimum point) plus the span value.</p> <p>For example, if the source signal is 4mA for a pressure of 1.00 megaPascals, enter 1.00 as the minimum point. If the source signal is 20mA for a pressure of 5.00 megaPascals, enter 5.00 as the maximum point.</p>
EXCEPT DEFLT	<p>If Default Value On Exception is enabled, the instrument will use the default value for the analog input that raised the exception. This will allow calculations to continue, however the exception message will continue to be displayed until the error is rectified or the input type is set to DEFAULT in calibration set mode.</p> <p>Press <input type="button" value="▲"/> or <input type="button" value="▼"/> to select ENABLE or DISABLE.</p>

Outputs

<input type="button" value="SET"/> ↓	<input type="button" value="▶"/> → UNITS PARAMS INPUTS OUTPUTS ALARMS COMMS TM/LOG SETUP TEST END
PULSE OUTn or 4-20	<p>You can assign any of the “main menu” variables to an output. The nature of the output depends on the assigned variable. Totals are output as pulses and rates are output as 4-20mA passive signals.</p> <p>Press <input type="button" value="▲"/> or <input type="button" value="▼"/> to select the variable that is required as an output. The top of the display shows the type of output signal that is assigned to the variable.</p> <p style="text-align: center;">CAUTION</p> <p style="text-align: center;">Due to the dual-purpose nature of the outputs, take care not to set the output as an open collector pulse type signal when connected to a 4-20mA loop circuit.</p>

SET ↓		▶ → UNITS PARAMS INPUTS OUTPUTS ALARMS COMMS TM/LOG SETUP TEST END
WIDTH	OUT _n	<p><i>The Output Pulse Width is available for viewing and editing only when the assigned variable is a total (pulse output) type.</i></p> <p>Pulse output is usually used to drive remote counters. Set the pulse width (in milliseconds) as required by the remote counter.</p> <p>Press ▲ or ▼ to set to: 10, 20, 50, 100, 200 or 500ms.</p>
PULSE	OUT _n	<p><i>The Output Pulse Factor is available for viewing and editing only when the assigned variable is a total (pulse output) type.</i></p> <p>The Output Pulse Factor is the scaling factor for the retransmission of the measured total quantity.</p> <p>For example, if “volume” is chosen as an output variable and engineering unit is cubic metres, then a pulse factor of 1.000 generates one pulse for 1 m³. Similarly, a pulse factor of 3.000 generates one pulse for 3 m³.</p> <p>For more information, see Output Pulse Factor on page 48.</p> <p>The output pulse factor cannot be 0 (zero).</p>
PT-MIN PT-MAX	OUT _n OUT _n	<p><i>The Output Minimum Point and Maximum Point are available for viewing and editing only when the assigned variable is a rate (4-20mA output) type.</i></p> <p>The output minimum value corresponds to the 4mA point and the output maximum value corresponds to the 20mA point.</p> <p>Setting the output range differently from the input range enables the instrument to amplify the input signal. You can drive a chart recorder that “zooms in” on a specified range of values instead of displaying the full operating range of the transducer.</p> <p>For example, if “volume flow” is chosen as an output variable and engineering unit is cubic metres per minute, then setting the minimum point to 30 and the maximum point to 100 would reflect the volumetric flow rate range of 30 to 100m³/min. At rates above the maximum and below the minimum points, the output remains at 20mA and 4mA respectively.</p>

Output Pulse Factor

Increasing the output pulse width reduces the maximum frequency at which a total variable can be retransmitted. Pulses will be missed if the output cannot “keep up” with the rate of total counts. You can use the output pulse factor to ensure that this maximum is not reached.

The maximum pulse output frequency is determined by:

$$\frac{1000}{(2 \times \text{pulse width in ms})} \text{Hz}$$

The minimum pulse factor required is determined by:

$$\frac{\text{max rate of total}}{\text{max pulse output frequency}}$$

For example: To calculate the required pulse factor to avoid losing counts in retransmission if a total counts at a maximum rate of 75 units/sec (Hz) and the required pulse width of a remote counter is at least 50ms:

The maximum pulse output frequency is: $\frac{1000}{2 \times 50} = 10\text{Hz}$

The minimum pulse factor for that frequency is: $\frac{75}{10} = 7.5$

Alarms



The alarm relay(s) can be assigned to rate variables such as flowrate, or set as an equipment failure alarm.

The alarm switches “on” whenever an alarm condition exists. The alarm switches “off” when the alarm condition no longer exists. However, you may need to configure external alarm devices that require acknowledgement for cancelling an alarm.

Equipment Failure Alarm

Any alarm relay can be assigned as an equipment failure alarm. This alarm setting can have normally closed (open) contacts that open (close) when the instrument displays any error message as listed in [Error Messages](#) on page 59.

<input type="button" value="SET"/> ↓	<input type="button" value="▶"/> → UNITS PARAMS INPUTS OUTPUTS ALARMS COMMS TM/LOG SETUP TEST END
RELAY ALRM n	<p>Select a rate variable to assign to the alarm relay.</p> <p>Note: If the alarm type is set to “equipment alarm”, this relay assignment setting is ignored.</p> <p>Press <input type="button" value="▲"/> or <input type="button" value="▼"/> to select the variable that is required as an alarm.</p>
TYPE ALRM n	<p>The options available for alarm types are as follows:</p> <ul style="list-style-type: none"> • HI-NO — High Alarm, Normally Open contacts • HI-NC — High Alarm, Normally Closed contacts • LO-NO — Low Alarm, Normally Open contacts • LO-NC — Low Alarm, Normally Closed contacts • BD-NO — Band Alarm, Normally Open contacts • BD-NC — Band Alarm, Normally Closed contacts • AL-NO — Equipment Alarm, Normally Open contacts • AL-NC — Equipment Alarm, Normally Closed contacts <p>Press <input type="button" value="▲"/> or <input type="button" value="▼"/> to select the type of alarm required.</p>
POINT ALRM n	<p><i>The Alarm Setpoint is available for viewing and editing for any alarm type except ‘equipment alarms’.</i></p> <p>The Alarm Setpoint is the value (in engineering units of assigned variable) at which the alarm condition occurs and therefore the alarm is on.</p> <p>Each alarm is completely independent, e.g. a High alarm does NOT need to have a higher setpoint than the a Low alarm.</p>

 ↓	 → UNITS PARAMS INPUTS OUTPUTS ALARMS COMMS TM/LOG SETUP TEST END
HYST ALRMn	<p><i>The Alarm Hysteresis is available for viewing and editing for any alarm type except 'equipment alarms'.</i></p> <p>Alarm hysteresis loops occur when the alarm toggles continuously on and off when the process variable is close to the setpoint.</p> <p>For a high alarm, the alarm activates when the value of the variable rises above the alarm setpoint and deactivates when the value falls below the alarm setpoint minus the amount of the hysteresis setting (if any).</p> <p>For a low alarm, the alarm activates when the value of the variable falls below the alarm setpoint and deactivates when the value rises above the alarm setpoint plus the amount of the hysteresis setting (if any).</p> <p>For a band alarm, the alarm activates whenever the value of the variable is outside the setpoint plus or minus the amount of the hysteresis.</p> <p>For example, with a high alarm setpoint of 200, and a hysteresis setting of zero, a value oscillating between 197 and 202 will cause the alarm to toggle on at 200 and toggle off below 200. However, if the hysteresis is set to 5, the value of the variable must fall below 195 to cancel the alarm. The alarm will reactivate only when the value again rises above 200.</p>

Communications

The instrument has the following communication ports:

- **COM-1 RS-232 Port** - A 9-pin female connector on the rear panel of the instrument.
- **COM-2 RS-485 or Ethernet Port (optional)** - Terminals or socket on the rear panel. Ethernet connection requires COM-2 setting to be: RTU (Modbus), 19200 Baud rate, even parity and 1 stop bit.
- **COM-3 Port** - A special communications port that is only applicable to some applications.

SET ↓	▶ → UNITS PARAMS INPUTS OUTPUTS ALARMS COMMS <small>TM/LOG SETUP TEST END</small>
PROTOC COM--n	<p>The Communications Protocols can be assigned to the communication ports as follows (a protocol cannot be assigned to more than one port at a time):</p> <ul style="list-style-type: none"> • ASCII - Simple ASCII • RTU - Modbus RTU • PRN - Printer Protocol • NONE - If a port is not being used, set the protocol to NONE. <p>Printer Protocol (PRN) is only available if the option with Real Time Clock is installed.</p> <p>For the selected port, press <input type="button" value="▲"/> or <input type="button" value="▼"/> to select the desired protocol.</p>
BAUD COM--n	<p>The Baud setting is the speed of the communication port in data bits per second.</p> <p>The baud rate of the instrument must match the baud rate of the communication device that the instrument is connected to.</p> <p>Use <input type="button" value="▲"/> or <input type="button" value="▼"/> to select 2400, 4800, 9600 or 19200 baud.</p>
PARITY COM--n	<p>The Parity bit helps to detect data corruption that might occur during transmission.</p> <p>The parity bit setting of the instrument must match the parity bit setting of the communication device that the instrument is connected to.</p> <p>Press <input type="button" value="▲"/> or <input type="button" value="▼"/> to select EVEN, ODD, or NONE.</p>
S-BITS COM--n	<p>The Stop bit indicates the end of a transmission. Stop bits can be 1 or 2 bit periods in length. The stop bit setting of the instrument must match the stop bit setting of the communication device that the instrument is connected to.</p> <p>Press <input type="button" value="▲"/> or <input type="button" value="▼"/> to select 1 or 2 stop bits.</p>

<input type="button" value="SET"/> ↓		<input type="button" value="▶"/> → UNITS PARAMS INPUTS OUTPUTS ALARMS COMMS TM/LOG SETUP TEST END
RTU	DATA	<p>The Modbus RTU data format for the 2-register (4-byte) values can be set as either floating point or long integer values.</p> <p>Use <input type="button" value="▲"/> or <input type="button" value="▼"/> to select FLOAT or INTEGER.</p>
RTU	ADDR	<p>The Modbus RTU protocol address must be in the range of 1 to 247. When multiple instruments (slaves) are connected to one communication device (master), each assigned address must be unique.</p> <p>Note: The master device uses the RTU address 0 (zero) for broadcasting to all connected slave units.</p>
ASCII	ADDR	<p>The ASCII protocol address identifies each communicating device.</p> <p>The address must be in the range of 1 to 255. When multiple instruments (slaves) are connected to one computer (master), each assigned address must be unique.</p>
FLASH	PORT	<p>The Flash Driver Port assignment defines the communication port for downloading software into the instrument.</p> <p>The default setting of this assignment is the RS-232 port. The Ethernet port, if fitted, can not be used as the Flash port.</p> <p>Press <input type="button" value="▲"/> or <input type="button" value="▼"/> to select RS-232 (COM-1), RS-485 (COM-2) or NONE.</p>

Time Settings and Data Logging

Instrument Clock

Note: The real-time clock is part of the advanced option package.

The instrument has a real-time clock for recording logged events. The clock displays the time and the date. The date format can be set to European format (day/month/year) or American format (month/day/year). The time clock uses the 24-hour format.

The clock will continue to operate for up to 5 years (typically) on the internal battery if there is no power connected to the instrument. Therefore, after an interruption to the power supply, the instrument recommences normal operation although there will be no data recorded during the period without a power supply.

Note: If there is an interruption to the power supply and the battery has failed, the instrument displays an error message when the power supply is restored. In this case, you should set the current time and date so that the instrument continues to log data at the correct times.

Data Logging

The instrument will log the main-menu variables if real-time clock option is installed. The logs are at fixed intervals of hours, days, weeks, months and years. The instrument can store a total of 1530 log entries which are distributed over the log intervals as follows:

- 800 hourly logs
- 400 daily logs
- 200 weekly logs
- 100 monthly logs
- 30 yearly logs

If the number of log entries exceeds the programmed number for a particular time interval, the oldest log entry is overwritten by the newest one for that time interval.

Also note that the totals are saved as accumulated totals.

The log parameters (below) also determine the number of records to be included in a report printout if the printing option is used.

SET ↓	▶ → UNITS PARAMS INPUTS OUTPUTS ALARMS COMMS TM/LOG SETUP TEST END
DATE FORM	<p>Clock Date Format</p> <p>The European date format is: dd/mm/yyyy or (Day-Month).</p> <p>The American date format is: mm/dd/yyyy or (Month-Day).</p> <p>Press ▲ or ▼ to select DAY-M or M-DAY</p>
CLOCK YEAR	The Clock Year defines the current year for the real-time clock.
CLOCK M-DAY	The Clock M-DAY setting defines the current month and date for the real-time clock. This parameter is programmed in Month-Day format for both European and American date formats.
CLOCK H-MIN	The Clock H-MIN setting is the current time in hours and minutes for the real-time clock.
HOUR LOGS	<p>Set the number of Hourly Logs to appear on the printed log report.</p> <p>The hourly log entry occurs at 00 minutes each hour.</p>







SET ↓		▶ → UNITS PARAMS INPUTS OUTPUTS ALARMS COMMS TM/LOG SETUP TEST END
DAY	LOGS	<p>Set the number of Daily Logs to appear on the printed log report.</p> <p>The daily log entry occurs at 00 hours and 00 minutes each day.</p>
WEEK	LOGS	<p>Set the number of Weekly Logs to appear on the printed log report.</p> <p>The weekly log entry occurs at 00 hours and 00 minutes each Monday.</p>
MONTH	LOGS	<p>Set the number of Monthly Logs to appear on the printed log report.</p> <p>The monthly log entry occurs at 00 hours and 00 minutes on the first day of the month.</p>
YEAR	LOGS	<p>Set the number of Yearly Logs to appear on the printed log report.</p> <p>The yearly log entry occurs at 00 hours and 00 minutes on the first day of the year.</p>
RESET	LOGS	<p>Reset the logged data. You may need to reset (clear) the logged data if you change the time/log settings.</p> <p>Press ▲ or ▼ to select YES, then press the SET key. The instrument makes three beeps to confirm the reset command.</p>
REPORT	TYPE	<p>The Printer Protocol Report Type determines the nature of the printout from the REPORT PRINT - HOLD.SET prompt in the main menu. The following report types available in this instrument are:</p> <ul style="list-style-type: none"> • REP-01 Hourly Logs Report • REP-02 Daily Logs Report • REP-03 Weekly Logs Report • REP-04 Monthly Logs Report • REP-05 Yearly Logs Report • REP-06 Previous Day's 24 Hour Report (0Hr – 23Hr, minimum 48 hourly logs required) <p>Press ▲ or ▼ to select Report Type.</p>

SET ↓	▶ → UNITS PARAMS INPUTS OUTPUTS ALARMS COMMS TM/LOG SETUP TEST END
PRN TYPE	<p>The Printer Protocol Printer Type allows the nature of the printer being used to be specified. The following printer types available in this instrument are:</p> <ul style="list-style-type: none"> • PRN-01 Generic computer printer • PRN-02 Generic roll printer (prints first line first) • PRN-03 Slip printer TM295 • PRN-04 Label (roll) printer - Citizen CMP30L <p>Press ▲ or ▼ to select Printer Type.</p>
PRINT ACCUM	Select whether the accumulated totals are printed in addition to the non-accumulated totals for printer protocol.

General Setup Parameters

SET ↓	▶ → UNITS PARAMS INPUTS OUTPUTS ALARMS COMMS TM/LOG SETUP TEST END
DEFAULT TOTAL	<p>The instrument displays the default Total when the user presses the TOTAL key.</p> <p>If the display timeout is enabled, the instrument displays the default Total when there is no user action for the period of the display timeout period.</p> <p>Press ▲ or ▼ to select the default total display.</p>
SUPPLY VOLT	<p>The instrument provides a power-limited supply for external transducers.</p> <p>Press ▲ or ▼ to set the transducer supply voltage between 8 and 24 volts DC as required.</p>

<div style="border: 1px solid black; padding: 2px; display: inline-block;">SET</div> ↓	<div style="border: 1px solid black; padding: 2px; display: inline-block;">▶</div> → UNITS PARAMS INPUTS OUTPUTS ALARMS COMMS TM/LOG SETUP TEST END
T--OUT MODE	<p>If the Display Timeout mode is enabled, and there is no user activity for the defined timeout period, the display panel returns to the default display.</p> <p>This function is useful for the following reasons:</p> <ul style="list-style-type: none"> • to return the display to a preferred variable after the user has finished reading other information, • to cancel the calibration mode and return to the default display if the user does not exit from the calibration mode for any reason. <p>Press <div style="border: 1px solid black; padding: 2px; display: inline-block;">▲</div> or <div style="border: 1px solid black; padding: 2px; display: inline-block;">▼</div> to select the display timeout function as follows:</p> <ul style="list-style-type: none"> • DISABLE - Timeout is completely disabled. • EN DISP - Timeout is enabled during Normal mode and Calibration View mode. • EN EDIT - Timeout is enabled during Calibration Set mode. • EN ALL - Timeout is enabled for all modes.
T--OUT SEC	<p>The Display Timeout period defines the delay for the Display Timeout mode if it is enabled.</p> <p>The display timeout period can be from 5 to 99 seconds.</p>
RESET MODE	<p>The Totals Reset mode can be configured to reset the non-accumulated totals to zero.</p> <p>Press <div style="border: 1px solid black; padding: 2px; display: inline-block;">▲</div> or <div style="border: 1px solid black; padding: 2px; display: inline-block;">▼</div> to select the reset mode as follows:</p> <ul style="list-style-type: none"> • NONE - The user cannot reset the non-accumulated totals. • INSTANT - When the user presses the RESET key, the instrument resets all non-accumulated totals. • DELAYED - When the user presses the RESET key and holds it for two seconds, the instrument resets all non-accumulated totals.
RESET ACCUM	<p>The Reset Accumulated Totals function clears all of the accumulated totals and the non-accumulated totals.</p> <p>Press <div style="border: 1px solid black; padding: 2px; display: inline-block;">▲</div> or <div style="border: 1px solid black; padding: 2px; display: inline-block;">▼</div> to select YES, then press the <div style="border: 1px solid black; padding: 2px; display: inline-block;">SET</div> key. The instrument makes three beeps to confirm the reset command.</p>

 ↓	 → UNITS PARAMS INPUTS OUTPUTS ALARMS COMMS TM/LOG SETUP TEST END
DISPL TAGS	<p>The Display Tags option determines whether the instrument displays the default display tags or the user-defined tags. The display tag setting also defines whether the instrument displays the default error and warning messages, or the user-defined messages.</p> <p>Note: The user-defined tags can be entered into the instrument only by the manufacturer or the distributor.</p> <p>Press  or  to select the Display Tags option as follows:</p> <ul style="list-style-type: none"> • DEFAULT - the instrument displays the default (English) tags • USER - the instrument displays the user-defined tags.
BACK-L T-OUT	<p>If the backlight timeout is enabled, and there is no user activity (any keys pressed) for a period of 10 seconds, the display backlight switches off to save power. The backlight switches on when a key is pressed. Select the backlight timeout mode as required.</p> <p>Press  or  to select ENABLE or DISABLE.</p>
RATES DP	<p>This parameter sets the maximum number of decimal places for displaying or printing main menu rates.</p>
TOTALS DP	<p>This parameter sets the maximum number of decimal places for displaying or printing main menu totals.</p>

Test Menu

The Test menu enables you to view the inputs and outputs to and from the instrument.

In Calibration Set mode, (by entering the system password) you can control the outputs and the alarms as described in the table below.

[SET] ↓	▶ → UNITS PARAMS INPUTS OUTPUTS ALARMS COMMS TM/LOG SETUP TEST END
AINP _n <i>units</i>	The units are displayed according to the calibration setup for the analog input. If unused or set to Default the input is 4-20mA and displayed in mA.
LINP _n STATE	You can view the state of the logic inputs. If the input is an open contact or inactive it will display HI . If the input is a closed contact or active it will display LO .
OUT _n STATE	<p>You can control the state of the outputs. Press the ▲ or ▼ keys to set the output state as follows:</p> <ul style="list-style-type: none"> • PROCESS - the output depends on the current values of the inputs and the calculations that the instrument performs. <p>For a pulse output, such as a total, the output produces a pulse train as follows:</p> <ul style="list-style-type: none"> • ON - a pulse train with a pulse width as set in the Outputs menu. • OFF - no output. <p>For a 4-20mA output, such as a rate, the output is as follows:</p> <ul style="list-style-type: none"> • HI - the output is set to 20mA. • LO - the output is set to 4mA.
ALRM _n STATE <i>or</i> REL - <i>n</i>	<p>You can control the state of the relays (alarms). Press the ▲ or ▼ keys to set the selected relay as follows:</p> <ul style="list-style-type: none"> • PROCESS - the relay operates according to the current values of the inputs and the relay settings as programmed. • OPEN - the relay output contacts are set to “open”. • CLOSED - the relay output contacts are set to “closed”.
SUPPLY V	<p>You can display the actual DC output supply voltage, which may help with troubleshooting.</p> <p>If the actual supply voltage is lower than the preset value (refer to General Setup Parameters on page 55) it may indicate that the output is overloaded.</p>

System Messages

The instrument displays messages for defined events and fault conditions.

The manufacturer or distributor can enter user-defined text for the messages. This user-defined text is displayed, instead of the default (English) messages, when the Display Tags option in the Setup menu is set to USER.

Error Messages

Failure of Analog Input Sensor

If there is a failure of an analog input sensor for a process parameter such as temperature or pressure etc, the instrument sets the value of that parameter to 0 and displays the relevant error message. The input sensor and connections need to be inspected and may require replacement.

The instrument also sets the results of calculations that depend on the failed input(s) to 0. For example, if the temperature sensor fails, the instrument displays a temperature reading of 0 and the calculated energy flow as 0.

Default Value on Exception

If Default Value On Exception has been enabled in the INPUTS section of calibration, the default value will automatically be used so that all calculations can continue. The error message will still continue to scroll across the display until the fault is corrected at which point the calculations will revert to using the live input.

Override Error Condition

While a fault is being rectified on an analog input for a process parameter, an operator with calibration access can set the Analog Input Signal Type to DEFAULT and the Analog Input Default Point to a typical process value. If there are no other faults, the instrument continues to operate by using the default value.

The system displays error messages as described in the following table:

Error Messages	Status Code	Description
CPU Card Failure	20	There are failed components on the CPU card and technical support is required.
Power Supply is Low	21	The input and/or output power supply voltage is too low, ensure that: (a) input power supply voltage is within the specified range (b) output power supply is not overloaded.
New/Failed Battery - Set Time	22	The real-time clock has lost the correct time because the battery has failed, or there is a new battery. Set the current time and date (in the TM/LOG menu) to clear the error message and to continue data logging at the correct times. Note: The instrument can continue operating with a failed battery, but the correct time will be lost if there are interruptions to the power supply.
Temperature Sensor Failure	01	The temperature sensor (analog input 1) has failed. To deactivate the error, the Analog Input Signal Type can be set to DEFAULT to use a programmed default value instead of the sensor signal.
Pressure Sensor Failure	02	The pressure sensor (analog input 2) has failed. To deactivate the error, the Analog Input Signal Type can be set to DEFAULT to use a programmed default value instead of the sensor signal.
Lo Range Flow Input Failure	03	The low range flow transmitter (analog input 3) has failed.
Hi Range Flow Input Failure	04	The high range flow transmitter (analog input 4) has failed.
Diameter Ratio is out of Range	05	The diameter ratio (beta) is out of the allowed range. The pipe and/or orifice diameters (specified in the Parameters menu) should be within the recommended limits of the DP flowmeter being used.
Temp/Pressure is Out of Range	10	The temperature and/or pressure inputs are outside of the allowed calculation range.
Invalid Specific Enthalpy Adjustment	06	The temperature and/or pressure (specific enthalpy adjustment conditions) are outside the allowed calculation range.

Warning Messages

The system displays warning messages as described in the following table:

Warning Messages	Description
Value Has Been Set to Default	You have entered an invalid value for a parameter. Therefore, the instrument has set the default value.
Over Total Limit - Maximum Set	You have exceeded the maximum number of logging entries for the combined time bases. The instrument has set the current log setting to the remaining maximum number.
Already Assigned to Other Port	You have tried to assign a particular protocol type to more than one serial communication port. The instrument has set the protocol to NONE.

Chapter 6

Communications

Overview

This chapter describes the communications between the instrument and another communicating device such as a computer or a printer. You should have relevant information about the devices to which the instrument will be connected. Some connection examples are included in this manual, however, the operation and connection of other devices is outside the scope of this manual.

Hardware Interconnection

The instrument has two communication ports:

- COM-1 RS-232 port on the rear panel (DB9 female connector)
- COM-2 RS-485 port on the rear panel (optional) or Ethernet (optional)

The appropriate interface and protocols are selected during calibration.

COM-1 RS-232 Port

The COM-1 RS-232 port provides communication between the instrument and one other device such as a host computer or a printer.

Note: A printer must have a serial port to be able to be directly connected to the flow computer. It is not possible to communicate directly with a printer via a parallel port.

Computers use either a DB9 or a DB25 connector, and the connections to each type are shown in Figure 19.

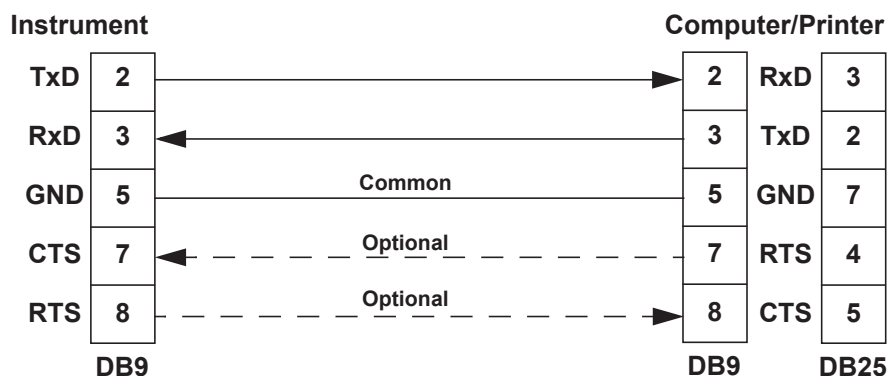

Figure 19 RS-232 Cable Connections to a Computer

Note: The instrument requires a cable with straight-through connections.
Do not use a null modem cable for RS-232 connection to a computer.

COM-2 RS-485 Port Option

The COM-2 RS-485 port enables communication with multiple devices. Each device has a unique address so that the “master” device can communicate with specific “slave” devices.

On RS-485 links, an external terminating resistor must be connected at the furthest end of the cable. When multiple instruments are connected, they should be “daisy chained” in a multidrop configuration as shown in Figure 20. Up to 32 units can be connected to the interface at a maximum distance of 1200 metres.

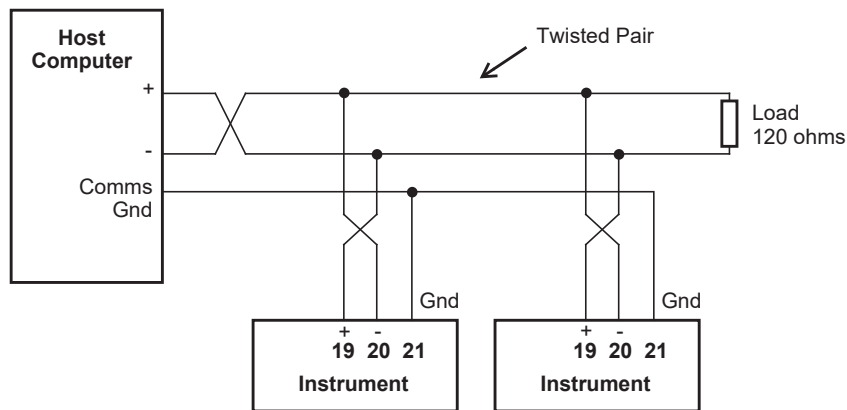

Figure 20 RS-485 Connections

COM-2 Ethernet Port Option

An Ethernet module is an available option, in place of the RS-485 port, if Modbus TCP/IP connection is required. In the programming communication settings, COM-2 should be set to RTU (Modbus), 19200 Baud rate, even parity and 1 stop bit.

For further advice and example of Ethernet port usage and setup, refer to [Ethernet Port & Setup](#) on page 88 in the Appendix.

Protocols

The communications protocols can be assigned to the communication ports on the instrument as follows:

- **ASCII** - Simple ASCII
- **RTU** - Modbus RTU
- **PRN** - Printer Protocol
- **NONE** - If a port is not being used, set the protocol to NONE.

Note: The Printer Protocol is only available if the option with Real Time Clock is installed. Also a protocol cannot be assigned to more than one port at a time as described in **Communications** on page 51.

- **ASCII** - In this ASCII protocol each command and response is a string of ASCII characters. This proprietary protocol is developed by Contrec to allow for simple information interchange. The main advantages of this mode are that it allows extended time intervals to occur between characters without causing a timeout error and that messages can be sent and monitored easily with a simple ASCII terminal.
- **Modbus RTU** - Modbus RTU is an industry-standard protocol which allows the instrument to be easily connected to computers running supervisory software systems. The main advantage of this mode is that its greater character density allows better data throughput than ASCII mode, however each message must be transmitted in a continuous stream.
- **Printer** - In the Printer protocol there is a selection of printer types. Please refer to the **Printer Protocol** on page 77 for full details.

Simple ASCII Protocol

This simple ASCII protocol requires that all requests are initiated with a colon (:) and terminated with a carriage return (C_R). The message termination can include a linefeed before the carriage-return ($L_F C_R$), but it is the carriage-return that acts as the message termination.

All responses by the instrument are terminated with a linefeed and a carriage-return ($L_F C_R$).

Requests Format

The format of a request to the instrument is as follows:

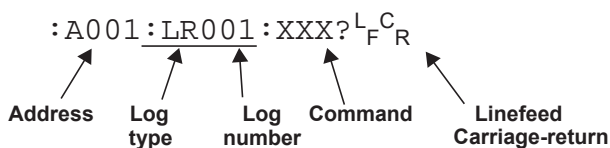

Each request must include the address and command portions. The underlined section is an optional part of the request string.

Address

In multipoint communications, each instrument must have a unique address and it is essential in the request for identifying a particular instrument. However, it may be set to 000, for special broadcast commands.

For single-instrument communications, the address can also be set to 000 in the request.

Refer to **Communications** on page 51 for setting the instrument address.

Note: The instrument always responds with its address in the header regardless of the type of request.

Log Type and Number

The log type and number enables a communicating device to retrieve data from the instrument. The data can be from timebased and/or event-based logs. Data can also be from the current process variables with the either accumulated or non-accumulated (resettable) totals.

All logged records of the process variables contain the accumulated totals.

The log request is optional. If the log request is not included, or the log number is set to 000, the instrument returns the current process variables. If the log request is included, the log number defines the specific log entry by counting backwards. The most recent log entry for a timebase is 001.

The “last edit” log records the process variables at the time of the last exit from the calibration edit mode. There is only one “last edit” log, therefore, if a number is included in the request, the instrument ignores the number and returns the data at the time of the last edit. Likewise, there is only one set of current process variables with “non-accumulated totals”, therefore it also ignores any log number included in the request.

The types of logs applicable to this instrument are as follows:

Log Type
LH - hourly log
LD - daily log
LW - weekly log
LM - monthly log
LY - yearly log
LE - last edit log
LN - current totals displayed as Non-accumulated

The number of the log entry is the same as shown on the front panel of the instrument. For example, a request for LH003 would return the data for the log entry two hours prior to the most recent hourly log entry. If the current time is between 9:00am and 10:00am, the most recent hourly log LH001 was recorded at 9:00. Therefore, LH002 is for 8:00 and LH003 is for 7:00. After 10:00am in this example, LH003 becomes the 8:00 log.

Instrument Responses

The instrument response time to any enquiry is not more than 300ms. The responses from the instrument are in the following format:

```

HEADERLFCR
DATALFCR
DATALFCR
.
.
.
DATALFCR
LFCR
    
```

The components of the response message are as follows:

Header

The format of the response header from the instrument is as follows:

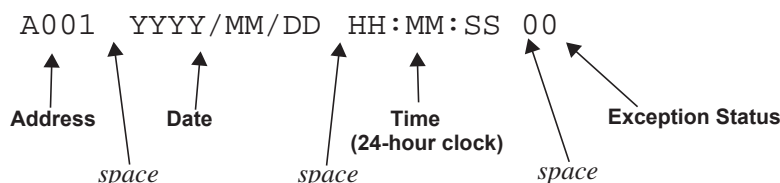

The instrument **Exception Status** codes that the instrument returns for the ASCII protocol are the same as those described for the Modbus RTU protocol in **Instrument Exception Status** on page 75.

Data

The format of the data variables from the instrument is as follows:

8 9 1 2 3 . 4 5 6								M W h						E N E R G Y											
1	2	3	4	5	6	7	8	9	10	11	12	13	14	15	16	17	18	19	20	22	23	24	25	26	27
Value (aligned right)											space	Unit (aligned left)						space	Item (aligned left)						

Note: The decimal point in the Value is always at character position 8. Therefore whole numbers are aligned right at the decimal point, with trailing zeroes.

Variables Request

The variables request asks the instrument to return the value of one or more requested variables. All totals are transmitted as accumulated totals.

Command	Description
:RVA?	Return all variables
:RVD?	Return the default Total and Rate
:RV0? ... :RV9?	Return the specific variable. The numbers relate to the position in the variables menu. For example, V0 is Energy, V1 is Power and so on.

Variables Request and Response Example

The following request is for the only instrument that is connected to the communication port to return the values of all main menu variables.

```
: A 0 0 1 : R V A ? LF CR
```

The following is an example of a hypothetical instrument response. Refer to on page 5 for the list of variables that would be returned for this application.

```
A 0 0 1 2 0 0 2 / 0 3 / 1 4 1 8 : 2 5 : 0 0 0 0 LF CR
      6 . 1 1 6 M W h E N E R G Y LF CR
      1 6 . 5 7 3 M W P O W E R LF CR
    1 3 2 0 . 5 3 0 m 3 V O L U M E LF CR
      5 8 . 3 0 0 m 3 / M V - F L O W LF CR
    7 6 2 7 . 1 1 7 K G M A S S LF CR
      3 4 4 . 4 6 0 K G / M M - F L O W LF CR
      2 3 0 . 0 0 0 D E G C T E M P LF CR
      1 . 2 6 0 M P A P R E S S LF CR
      0 . 1 7 4 m 3 / K G S P - V O L LF CR
    2 8 8 6 . 7 6 0 K J / K G S P - E N T LF CR

LF CR
```

The following message to an instrument, requests the current values for the default rate and total:

```
: A 0 0 1 : R V D ? LF CR
```

The instrument response would be similar to the following:

```
A 0 0 1 2 0 0 2 / 0 3 / 1 4 1 8 : 2 5 : 0 0 0 0 LF CR
      1 2 6 . 4 5 5 m 3 V O L U M E LF CR
      2 0 . 4 3 7 m 3 / M V - F L O W LF CR

LF CR
```

Log Request

The log request asks the instrument how many logs it stores in the particular timebase. These are the values described in **Time Settings and Data Logging** on page 52.

Command	Description
:RLH?	Return the number of hourly logs
:RLD?	Return the number of daily logs
:RLW?	Return the number of weekly logs
:RLM?	Return the number of monthly logs
:RLY?	Return the number of yearly logs
:RLR?	Return the number of log records (non- timebased logging)

Log Response Example

The following message asks the instrument with address 001 to return the number of logs that the instrument stores:

```
: A 0 0 1 : R L R ? LF CR
```

The instrument response would be similar to the following:

```
A 0 0 1 2 0 0 2 / 0 3 / 1 4 1 8 : 2 5 : 0 0 0 0 LF CR
2 4 LF CR
LF CR
```

Clear Data Request

The clear data request asks the instrument to clear the data in the selected registers.

Command	Description
:RCN?	Clear the non-accumulated (resettable) totals
:RCA?	Clear the accumulated totals
:RCL?	Clear the logs except for the “last edited” log

Clear Data Request Example

The following message asks the instrument with address 001 to clear the logged data that the instrument stores:

```
: A 0 0 1 : R C L ? LF CR
```

The instrument response would be similar to the following:

```
A 0 0 1 2 0 0 2 / 0 3 / 1 4 1 8 : 2 5 : 0 0 0 0 LF CR
LF CR
```

Instrument Information Request

The Instrument Information request asks the instrument to return the general information about the model and version codes. The instrument exception status is returned as a part of the header as it is with the header for all command responses.

Command	Description
:RIG?	Return the general information about the instrument such as Model number, Application number, Version and Serial numbers etc. These items are returned as a block in the same format as shown on the display in the “Model Info” menu.

Instrument Information Response Example

The following message asks the instrument with address 001 to return the general information about the instrument:

```
: A 0 0 1 : R I G ? LF CR
```

The following is an example of a hypothetical instrument response:

```
A 0 0 1 2 0 0 2 / 0 3 / 1 4 1 8 : 2 5 : 0 0 0 0 LF CR
5 1 5 M O D E L - 1 1 - F - LF CR
S C 0 1 I N P U T F - T P - - LF CR
S C 0 1 V E R S 0 1 0 1 . 0 0 1 LF CR
C U S T O M V E R S 0 0 0 0 0 1 LF CR
U N I T S / N 1 2 3 4 5 6 LF CR
LF CR
```

1	2	3	4	5	6	7	8	9	10	11	12	13	14	15	16	17	18	19	20	21	22	23	24	25	26	27	28	29
---	---	---	---	---	---	---	---	---	----	----	----	----	----	----	----	----	----	----	----	----	----	----	----	----	----	----	----	----

Corrupted or Invalid Requests

If the instrument receives a corrupted or incomplete request, there is no response. The instrument discards any partial request and waits for the next enquiry.

If the instrument receives a request message in the correct format, but for a non-existent option, it returns only the message header. For example, if the instrument received the following request variables message :A001:RVT? it will return only the header because there is no T option for the ‘Variables Request’ message.

Modbus RTU Protocol

Modbus RTU (remote terminal unit) is an industry standard protocol that allows the instrument to be easily interfaced to other communication devices.

The instrument implements the Modbus protocol as detailed in the *Modicon Modbus Protocol Reference Guide* PI-MBUS-300 Rev J (June 1996).

Message Format

In RTU mode, messages start with a silent interval of at least 3.5 character times. The first field transmitted is the device address. Following the last transmitted character, a similar interval of at least 3.5 character times marks the end of the message. A new message can begin after this interval. The entire message frame must be transmitted as a continuous stream. A typical message frame is shown below:

Address	Function	Data	CRC Check
1 byte	1 byte	n bytes	2 bytes

Except for broadcast messages, when a master device sends a query to a slave device, it expects a normal response. One of four possible events can occur from the master's query:

- If the slave device receives the query without a communication error, and can handle the query normally, it returns a normal response.
- If the slave does not receive the query due to a communication error, no response is returned. The master program has to process a timeout condition for the query.
- If the slave receives the query, but detects a communications error (parity or CRC), no response is returned. The master program has to process a timeout condition for the query.
- If the slave receives the query without a communication error, but cannot handle it (for example, if the request is to read a nonexistent register), the slave will return an exception response informing the master of the nature of the error.

Instrument Address

The address of the instrument is programmable in the range from 1 to 247. Some addresses are reserved according to PI-MBUS-300 and have a special meaning:

- 0 = Broadcast, no response required from slave devices
- 248 to 255 Reserved

Function Codes

The instrument accepts the following function codes:

Code	Name	Description
03	Read data register(s)	Obtain the content of one or more 2-byte data registers.
06	Preset data register	Preset one 2-byte data register.
07	Read status register	Obtain the content of 1-byte status register.
16	Preset data register(s)	Preset one or more 2-byte data registers.

Exception Response

The instrument forms an exception response by adding 80H to the function code and using an exception code as the 1-byte data field in the returned frame. Implemented exception codes are as follows:

Code	Name	Description
01	Illegal function	The function code is not a legal action for the slave.
02	Illegal data address	The data address is not a legal address for the slave.
03	Illegal data value	The data value is not a legal value for the slave.
05	Acknowledge	The slave has accepted the request and is processing it, but a long duration of time will be required to do so.
06	Slave device busy	The slave is engaged in processing a long duration program command. The master should re-transmit the message later when the slave is free.

List of Data Registers

The following tables describe the addresses and meaning of the data registers in the instrument. The registers are grouped in blocks that relate to a particular function of the instrument. The data values are expressed in the engineering units that were selected for the variables when the instrument settings were configured.

Note: Conventional numbering of registers often starts from 1, therefore be aware that “register 1” in this case has “address 0” and so on.

The data registers represent different data types as specified in the tables:

- I - Integer, 2 bytes (Holding Register)
- L - Long Integer, 4 bytes (2 registers)
- P - Programmable Format, 4 bytes (2 registers)

The “Programmable Format” data type for 4-byte (2 registers) data values can be set as either Floating Point or Long Integer via the “Data Type” program item as described in **Communications** on page 51.

The Floating Point variable is represented in IEEE-754 Floating Point 4-byte format and requires two 2-byte data registers:

IEEE-754	Modicon Registers
1st byte	low byte (register X)
2nd byte	high byte (register X)
3rd byte	low byte (register X+1)
4th byte	high byte (register X+1)

This means that two data registers must be read or written to obtain, or preset, one data value.

Current and Logged Process Data

This block of registers is available for the retrieval of current or logged process data with its matching time and date information.

Use the log type and log number to retrieve the logged information from the appropriate register. If a particular log number does not exist, or the instrument does not have the optional real-time clock, the time and date stamp and associated variables are set to zero.

Register	Name	Comments	Read Only or Read/Write	Type
1	Energy	<p style="text-align: center;">Process Variables</p> <p>By default totals are the Accumulated values. If current Non-accumulated (resettable) totals are required, set register 37 to 06. All logged totals are the Accumulated values.</p>	R	P
3	Power		R	P
5	Volume		R	P
7	Volume Flowrate		R	P
9	Mass		R	P
11	Mass Flowrate		R	P
13	Temperature		R	P
15	Pressure (absolute)		R	P
17	Specific Volume		R	P
19	Specific Enthalpy		R	P
21	Specific Enthalpy Adjust		R	P
23	Specific Enthalpy Net		R	P
25	Differential Pressure		R	P
27	Reynolds Number		R	P
29		R	P	
31	Year	<p style="text-align: center;">Current Date/Time or Logged Date/Time Stamp (see register 38 Log Number). Only current Date/Time can be edited</p>	R/W	I
32	Month		R/W	I
33	Date		R/W	I
34	Hour		R/W	I
35	Minute		R/W	I
36	Second		R	I
37	Log Type	00 - hourly or log records 01 - daily 02 - weekly 03 - monthly 04 - yearly 05 - last edit of calibration 06 - current totals are non-accumulated values, register 38 is ignored.	R/W	I
38	Log Number	If set to 0, current variables and Date/Time are retrieved	R/W	I
39	Clear Data	01 - clear logs 02 - clear accumulated totals 03 - clear non-accumulated totals	W	I
40	Reserved			

Instrument Exception Status

This register is available to verify the status of the instrument.

Register	Name	Comments	Read Only or Read/Write	Type
41	Exception Status	00 = no error 01 = analog input 1 failure 02 = analog input 2 failure 03 = analog input 3 failure 04 = analog input 4 failure 05 = invalid calibration parameter 06 = invalid reference parameter 07 = invalid property 08 to 09 reserved 10 = process parameters out of range 11 = input is over limit 12 = flow error detected 20 = system failure 21 = power supply is low 22 = new or failed clock battery 23 to 29 reserved 30 = alarm 1 active 31 = alarm 2 active 32 = alarm 3 active 33 = alarm 4 active	R	I

Instrument Control and I/O

This block of registers is available in some applications to give access to monitor and/or control some of the instrument.

Register	Name	Comments	Read Only or Read/Write	Type
42	Reserved			
43	Logic Inputs	0 to 15 Binary representation of logic inputs B0 = 0/1 (LSB) input 1 activated/deactivated B1 = 0/1 input 2 activated/deactivated B2 = 0/1 input 3 activated/deactivated B3 = 0/1 input 4 activated/deactivated	R	I
44	Operation Mode	Representation of operation mode 0 = Idle/Local Idle state 1 = SAT-T Saturated steam, temperature 2 = SAT-P Saturated steam, pressure 3 = SUPER-1 Superheated steam, standard 4 = SUPER-2 Superheated steam, type 2 5 = SUPER-3 Superheated steam, type 3 6 = LIQUID Liquid water	R	I
45	Relay State	0 to 15 Binary representation of relay state. 0 = open; 1 = closed. B0 = relay 1 (LSB) B1 = relay 2 B2 = relay 3 B3 = relay 4	R	I

Register	Name	Comments	Read Only or Read/Write	Type
46	Relay Control	0 to 15 Binary representation of relay control. 0 = open; 1 = close. B0 = relay 1 (LSB) B1 = relay 2 B2 = relay 3 B3 = relay 4	R/W	I
47	Relay Control Source	0 to 15 Binary representation of relay control source. 0 = Local (controlled by instrument operation) 1 = RTU (controlled by Modbus register 46). B0 = relay 1 (LSB) B1 = relay 2 B2 = relay 3 B3 = relay 4	R/W	I
48	Reserved		R	L
51 to 99	Reserved		R/W	P
101	Analog Inp.1	Raw analog input data.	R	P
103	Analog Inp.2	4-20mA inputs are read in Amperes.	R	P
105	Analog Inp.3	0-5V or 1-5V inputs are read in Volts	R	P
107	Analog Inp.4	RTD inputs are read in degrees Kelvin. Unused inputs are configured as 4-20mA.	R	P

Printer Protocol

A printer protocol is available in the 500 Series. It provides the ability to print out live data, individual logged data and to do some report-style printing of logged data. The method of printing these and the format of the printouts is described below.

Note: Printer output is only available if the Real Time Clock option is fitted.

The selection of Printer Protocol can be made for the Communications Protocol options for the COM-1 RS232 or COM-2 RS485 port. A list of log report types and printer types available at the end of the TM-LOG calibration menu.

Report Types

The list of report types is as follows:

- REP-01 Hourly Logs Report
- REP-02 Daily Logs Report
- REP-03 Weekly Logs Report
- REP-04 Monthly Logs Report
- REP-05 Yearly Logs Report
- REP-06 Previous Day Hourly Logs (0Hr – 23Hr, minimum 48 hourly logs required)

The number of logs printed in each report is determined by the values programmed in the TM-LOG menu.

Printer Types

The list of available printers is as follows:

- PRN-01 Generic computer printer
- PRN-02 Generic roll printer (printing first line first)
- PRN-03 Slip Printer TM295
- PRN-04 Label (roll) printer - Citizen CMP30L

Customizing a Printout

A customized printout can be provided which can have up to 6 header lines and 6 footer lines. It is also possible to include or exclude each main menu item on the printout. If any customizing of the printout is required discuss this with the distributor.

Types of Printouts

Live Data

The RESET key, when in main menu, is shared as the PRINT key if the printer protocol has been selected. A printout will be initiated whenever this key is pressed. If printing is not required, do not select printer protocol.

The format of this printout will be:

Custom Header Lines

Current Docket No.

Instrument Serial No. & Tag

Current Date & Time & Status

<i>Total Variable</i>	<i>unit</i>	<i>value</i>	<i><Resettable total first></i>
<i>Total Variable</i>	<i>unit</i>	<i>value (acc)</i>	<i><Accumulated total second></i>
<i>Variable</i>	<i>unit</i>	<i>value</i>	
<i>Variable</i>	<i>unit</i>	<i>value</i>	

etc.

Custom Footer Lines

----- *<separation line>*

(Note that blank header and footer lines are not printed).

Docket Number

The docket number that appears on the live data printout indicates the print number. This number is cleared when the Accumulated totals are reset. If the Reset Mode is set for Delayed, where a print can be generated without resetting the non-accumulated totals, an additional number in brackets will be shown that indicates the number of prints since the last reset. i.e.

DOCKET No. *000256* *(000036)*

Instrument Serial Number and Unit Tag

The instrument serial number and unit tag is the same as the information shown in the Model Info menu. For more details refer to **Model Information** on page 30.

Individual Log Data

When in the Log Menu and while holding the DISPLAY key to view the data of the log of interest the RESET key can be pressed to initiate a printout of that log entry. The printout will have the time and date stamp corresponding to when the log was taken. After the print has been initiated there will be the opportunity to scroll to view another log entry and print again.

Since in each log entry all totals are stored as the Accumulated value, the printout will not have any resettable totals. The format of the printout with this exception is the same as the LIVE DATA printout:

Custom Header Lines

Instrument Serial No. & Tag

Log Date & Time & Status

```
Variable                unit  value  <example: total as Accum only>
Variable                unit  value
etc.
```

Custom Footer Lines

----- <separation line>

Log Report Printing

As there is the likelihood that the reports can be of a considerable length it is strongly recommended that only the 80 Column printer with Z fold (tractor feed) paper be used. This is just as much for the memory storage of printer as it is for the reliable paper supply.

There is a HOLD.SET REPORT PRINT prompt under the main menu with the ability to print the pre-selected type of report. Pressing and holding the SET key for two seconds will initiate the printout. Any of the Log Reports will have the following format:

Custom Header Lines

Title of Report <internally set, indicates report type>

Current Date & Time

Instrument Serial No. & Tag

----- <separation line>

Log No. Date & Time & Status

```
Variable                unit  value  <example: total as Accum only>
Variable                unit  value
etc.
```

----- <separation line>
Log No. Date & Time & Status
Variable unit value <example: total as Accum only>
Variable unit value
etc.

----- <separation line>
Log No. Date & Time & Status
Variable unit value <example: total as Accum only>
Variable unit value
etc.

Custom Footer Lines

----- <separation line>

Reports will print in the historical order, and for those logs that have no data (e.g. unit was powered off at the time) the print will show “Data not available”, i.e.

Log No. Date & Time & Status
Variable unit value <example: total as Accum only>
Variable unit value
etc.

----- <separation line>

Log No. Data Not Available

----- <separation line>

Log No. Date & Time & Status
Variable unit value <example: total as Accum only>
Variable unit value
etc.

If the unit is programmed for 0 logs for a particular time base then the report for that time base will only consist of the header and ID information and a “Data Not Available” message. Likewise for the 0Hr to 23Hr report to print the complete report there must be a minimum of 48 hourly logs programmed otherwise “Data Not Available” will be printed for the missing logs.

Custom Header Lines

Title of Report

Current Date & Time
Instrument Serial No. & Tag

Data Not Available

Custom Footer Lines

----- <separation line>

Printer Data Control

Some printers have limited data buffers and are therefore unable to collect all the print data being transmitted. The 500 Series has the capability of software handshaking. The Xon/Xoff characters can be used by any of the printer types to control the flow of data to ensure that data is not lost.

Some printers will also transmit an Xoff character in response to other events such as printer being off-line, print head not engaged or power being removed. The specific behaviour of the printer being used should be noted.

Error Messages

There are two printer error messages that can be displayed.

PAPER OUT

This message is related to the Printer Type PRN-03 TM295 Slip printer. It is standard procedure with this printer to check for paper status before printing. If a print is attempted but there is no paper the PAPER OUT message will be scrolled. The instrument will continue to poll the printer for paper and if paper is detected before a communications timeout expires the print will commence.

COMMS TIMEOUT

This message is relevant for all printer types and will be activated for the following conditions.

1. If the flow of data is stopped due to software or hardware handshaking and is not allowed to resume before the communications timeout.
2. If Printer Type is PRN-03 Slip printer and a paper status is requested but no response is received within the timeout period.
3. Paper Out has been detected for Printer Type PRN-03 but no paper is inserted within the timeout period.

When a communications timeout error has been activated the message COMMS TIMEOUT will be scrolled once, the request to print will be cleared and the instrument will return to its normal mode.

Appendix A

Glossary

500-PM Software	The 500 Series Program Manager (500-PM software) is a Windows based program that is freely available from the download section of the Contrec website. The program is a comprehensive configuration tool and resource centre that can be used to tailor an instrument to suit specific application needs including program settings, units of measurement, custom tags/text, access levels and more. Custom versions can be saved and configuration reports generated as a PDF.
ASCII	American Standard Code for Information Interchange. For the ASCII protocol, the instrument receives and transmits messages in ASCII, with all command strings to the instrument terminated by a carriage return. Replies from the instrument are terminated with a line-feed and a carriage-return.
Absolute Pressure	<p>Absolute Pressure = Atmospheric Pressure + Gauge Pressure.</p> <p>It is the combined local atmospheric pressure and the gauge pressure. All calculations are based on absolute values for pressure. Some sensors can directly measure the absolute pressure value while others measure gauge pressure. Pressure can be displayed as absolute or gauge and is indicated with an 'A' or 'G' appended to the pressure units of measure.</p>
Atmospheric & Gauge Pressure	Some sensors only measure gauge pressure, in this case the atmospheric pressure must be programmed to determine the absolute value. The atmospheric value is affected by the altitude of the installation. The atmospheric pressure default is 101.325 kPa (14.696 psia) which is the standard value at sea level.
IAPWS	International Association for the Properties of Water and Steam
IAPWS-IF97	IAPWS Industrial Formulation for the Thermodynamic Properties of Water and Steam. IAPWS-IF97 replaces the previous industrial standard IFC-67.
Modbus RTU	The Modbus protocol is a message structure for communications between controllers and devices regardless of the type of network. In RTU (remote terminal unit) mode, each 8-bit byte in a message contains two 4-bit hexadecimal characters. This mode has greater character density than ASCII and allows better data throughput than ASCII for the same baud rate.
Normalised Input	A normalised input ranges from 0 to 1.000. For 4-20mA input, the signal is set to 0 at 4mA and the signal is set to 1.000 at 20mA.
Passive Output Signal	Requires an external power supply.

RTD Resistance Temperature Device

**Watchdog
Timer (WTD)** The WDT is used to monitor the activity of the micro processor and will force a reboot if the micro processor stops, while power is applied, due to any internal or external influences.

Appendix B

Model Numbers

Product Codes

Model	Supplementary Code		Description
515	- SC04		
Enclosure	1		Panel mount enclosure
	2		Field mount enclosure (NEMA 4X / IP66)
	3/5		Explosion proof Ex d (IECEX/ATEX), metric glands (5 specifies heater)
	4/6		Explosion proof Ex d (CSA), NPT glands (6 specifies heater)
Output Options	0		4 logic inputs, 1 isolated output, 2 relays (only relay type 1 is available), RS232 (DB9) communication port
	1		4 logic inputs, 2 isolated outputs, 4 relays, real-time clock data logging, RS232 (DB9) and RS485 communication ports
	2/3		4 logic inputs, 2 isolated outputs, 4 relays, real-time clock data logging, RS232 (DB9) and Ethernet communication ports
Relay Type	1		Electromechanical relays only
	2		2 electromechanical and 2 solid state relays
	3		Solid state relays only
Power Supply	U		Inputs for 12-28VDC and 100-240 VAC, 50-60Hz <i>(Previous Models: A = 110/120 VAC, E = 220/240 VAC)</i>
	D		Input for 12-28VDC power only
Display Panel Options	S		Standard option (now with backlight & LCD backup) <i>(original Full option: F, with Infra-Red comms, no longer available)</i>
PCB Protection	C		Conformal coating - required for maximum environmental operating range. Recommended to avoid damage from moisture and corrosion.
	N		None - suitable for IEC standard 654-1 Climatic Conditions up to Class B2 (Heated and/or cooled enclosed locations)
Application Pack Number	SC04		Defines the application software to be loaded into the instrument
For example: Model No. 515.111USC Displayed on the 500 Series as: Note: The first character represents the CPU installed (factory use only). The remaining 6 characters only represent hardware that affects the operation.			

Note: Example full product part number is 515.111USC-SC04 (This is the number used for placing orders).

Custom Version Codes

	Code		Description
Origin Code Identifies Distributor	00		Factory Default Application
	01		Contrec Systems Pty. Ltd. Melbourne Australia
	02		Contrec Limited. West Yorkshire UK
	03		
	04		Contrec - USA, LLC. Pelham AL 35124 USA
	05		Flowquip Ltd. Halifax UK
	06		
	etc.		
User Language	0		English (Default)
	1		German
	2		Dutch
	3		French
	4		Spanish
	5		
	etc.		
Distributor's Code	000		Distributor's own choice. Possibly a code that identifies the customer and the application.
	...		
	999		
For example: 02 3 157 Displayed on the 500 Series as:			023 157 CUSTOM VERS

Application Information Code

The Application Information code is an aid for users and service personnel to determine the type of inputs that are used in a particular application. The Application Information code is displayed on the instrument as shown below.

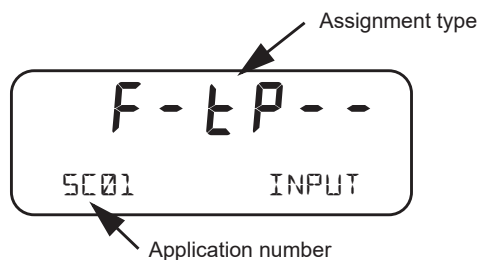

The Application number identifies the application as in the following examples:

- SC01 - steam flow computer for frequency flow meter
- GN02 - natural gas flow computer for analog flow meter

The Input Assignment type indicates the physical input that is assigned to each input on the instrument. The code is made up from six characters as follows:

FINP1	FINP2	AINP1	AINP2	AINP3	AINP4
X	X	X	X	X	X

The codes are as follows:

- - - not used in this application
- *A* - indicates a generic analog input such as for density or level etc.
- *U* - indicates a user code input
- *d* - indicates a density input
- *F* - indicates a generic flow input such as for volume or mass etc.
- *H* - indicates a high flow input for stacked inputs
- *L* - indicates a low flow input for stacked inputs
- *P* - indicates a pressure input
- *Q* - indicates a quadrature input
- *t* - indicates a temperature input.

For example, *F - t P - -* is an instrument with FINP1 (frequency input 1) assigned to a flow input, AINP1 assigned to a temperature input and AINP2 assigned as a pressure input. The other inputs are not used.

Appendix C

Ethernet Port & Setup

Ethernet Port

The optional Ethernet port simplifies the communication network and avoids the need for an external 3rd party Serial to Ethernet converter. It allows communications via an existing Ethernet network. In some installations you will need to speak with your network (IT) administrator in order to correctly set up your network. Applications, such as DataMod (available via Contrec), can communicate over the Ethernet network to perform remote monitoring and Data Logging operations.

Within the instrument's calibration menus the Ethernet port uses the settings for the RS-485 port that need to match a supplied Ethernet unit as follows:

- Protocol: RTU
- Baud Rate: 19200
- Data Bits: 8
- Parity: Even
- Stop Bits: 1

Data mapping follows the same convention applied to Modbus registers.

Connecting 515 Ethernet to Networks/Routers

Ethernet 515s are set as default to DHCP (Dynamic Host Configuration Protocol), which should allow your network/router to automatically find and assign an IP address to the instrument (providing there are addresses available). If your network cannot locate the instrument you may need to run the 'Digi Discovery' tool (Contrec guide available on request) or enter the Ethernet module's MAC address within your router settings. If required, the instrument can also be set to a static IP address, however it is strongly advised that only IT competent persons access and edit site network and 515 Ethernet settings. All Ethernet instruments are supplied with the Ethernet module MAC address printed on the outside of the enclosure and also printed directly onto the Ethernet Module itself (the Option card would need to be removed to view the physical Digi Ethernet module).

Contrec Limited will not be held responsible for any changes made to customer router and network settings. Further guides on how to access the module settings and discovering IP address' can be supplied upon request.

Connecting DataMod via Ethernet

Using the IP address that you or the network/router has assigned to the 515 instrument, enter this into the **Host Name / IPv4 Address** tab within DataMod's Modbus Connection Settings as per Figure 21.

Ensure all other settings are correct as per the **Datamod User Guide** and the **515 Ethernet Guide - Establishing a Connection to Datamod**. Both of these documents are available from Contrec on request.

The image shows a 'Modbus Connection Settings' dialog box with the following configuration:

- Transmission Mode:** TCP/IP
- RTU Serial Settings:**
 - Serial Port: COM1
 - Baud Rate (bps): 19200
 - Data Bits: 8 bits
 - Parity: Even
 - Stop Bits: 1 bit
- TCP/IP Settings:**
 - Host Name / IPv4 Address: 192.168.0.7
 - Port: 502
 - Receive Timeout (sec): 2
 - Maximum Retries: 2
 - Slave Unit Address: 1

Buttons: OK, Cancel

Figure 21 DataMod - Modbus Connection Settings

Appendix D

Reference Tables

Properties of Commonly Used Materials

Material	Linear Coefficient of Thermal Expansion in PPM/°C	Linear Coefficient of Thermal Expansion in PPM/°F
AISI 304 (Stainless Steel)	17.0	30.6
AISI 310 (Stainless Steel)	14.4	25.9
AISI 316 (Stainless Steel)	16.7	30.1
AISI 420 (Stainless Steel)	10.0	18.0
Monel	14.3	25.7
Carbon Steel	11.2	20.2

Index

Numerics

0-5V input 15

4-20mA

input 16

output 18

500 Series Program Manager 6

500-PM software 6, 83

A

ACCUM key 26

address, instrument 66

alarm

connection 20

equipment failure 48

hysteresis 50

relays 48

setpoint 49

alarms menu 48

analog input

connections 15

failure 59

scaling 4

application code 86

approvals 8

FCC Declaration 8

ASCII protocol 65

B

back panel 12

backup

program 35

Program Manager 35

basic menu 28

battery

failed 60

life 52

new 60

battery replacement 24

battery type 24

baud rate 51

C

CAL switch-protected parameter 31

calculation

superheated steam 3

calibration

backup, reports 35

menu 36

set mode 32

view mode 32

cleaning 11

clock

battery 52

date format 53

real-time 52

codes

application information 86

customer version 86

exception 75

product number 85

coefficients, expansion 90

comm port

COM-1 RS-232 63

COM-2 RS-485 64

communication

connections 22

protocols 65

communications 5, 63

menu 51

connections

alarm 20

communication 63

communications 22

electrical 12

input 15

mains 23

output 18

customer version codes 86

customizing a printout 77

D

daily logging 54

data log

viewing 28, 29

data logging
 daily 54
 hourly 53
 monthly 54
 weekly 54
 yearly 54
date format 53
declaration FCC 8
decontamination 11
default on exception 59
default total 25
detail menu 28
disconnection device 23
display
 specifications 9
 timeout mode 56
 timeout time 56
DISPLAY key 26
display-only parameter 31

E
earthing 23
electrical connections 12
energy offset 2
equipment failure alarm 48
error condition, override 59
error messages 59
Ethernet COM-2 port 23, 64
exception codes 75
Exception Status 67
exception, default 59
expansion coefficients 90

F
failure of input 59
features 1
flash driver port assignment 52
format, date 53
front panel
 keys 26
 LEDs 25

G
glossary 83

H
hardware connections 63
hourly logging 53
hysteresis, alarm 50

I
IAPWS-IF97 3
input
 0-5V 15
 4-20mA 16
 connections 15
 analog 15
 failure 59
 RTD 16
 sensor failure 59
 types 6
inputs menu 41
installation 11
instrument
 address 66
 request format 65
 responses 67
 settings 38
interconnections, communication 63
interference suppression 21
ISO 5167-1 1
isolated outputs 5

K
key
 ACCUM 26
 DISPLAY 26
 RATE 26
 RESET 26
 TOTAL 26
keys, front panel 26

L
LEDs, status 25
logged data 28
 viewing 29
logging
 daily 54
 hourly 53
 monthly 54
 weekly 54
 yearly 54
logic input connection 17

M
main menu
 basic and detailed 28
main menu items 27
mains connections 23

maintenance 11, 23
menu
 alarms 48
 calibration 36
 comms 51
 inputs 41
 outputs 46
 params 39
 setup 55
 test 58
 tm/log 52
 units 38
messages
 error 59
 system 59
 warning 61
Modbus data format 52
Modbus RTU protocol 71
mode
 display timeout 56
 normal operation 25
 operation 2
 set calibration 32
 view calibration 32
model numbers 85
monthly logging 54
mounting 11

N
normal operation 25
number
 model 85
 serial 30

O
operation mode 2
operation, normal 25
output
 connections 18
 4-20mA 18
 pulse 19
 pulse factor 48
outputs menu 46
override error condition 59

P
panel
 LEDs 25
 mounting 11
 rear 12
parameter
 CAL switch-protected 31
 display-only 31
 not visible 31
 password-protected 31
 programmable 31
parameters menu 39
parity bit 51
password-protected parameter 31
peak flowrates 28
port
 assignment, flash driver 52
 COM-1 RS-232 22, 51
 COM-2 Ethernet 23, 64
 COM-2 RS-485 22, 51
 COM-3 51
 flash driver assignment 52
power supply interruption 52
printer
 data control 81
 error messages 81
 protocol 77
 report types 77
printer types 77
printout
 configuration report 35
printouts
 individual logs 79
 live data 78
 log report 79
 types 78
product number codes 85
Program Manager 35
programmable parameter 31
protocol
 ASCII 65
 communication 65
 Modbus RTU 71
 printer 77
pulse factor, output 48
pulse output 19

R

RATE key 26
real-time clock 52
rear panel 12
relay outputs 6
relays, alarm 48
Remote Reset 26
RESET key 26
responses, instrument 67
RS-232 COM-1 port 22, 51
RS-485 COM-2 port 22, 51
RTD input 16
RTU protocol 71

S

scaling analog input 4
serial number 30
setpoint, alarm 49
settings
 instrument 38
setup menu 55
shielding 23
snubber 21
software configuration tool 6
specific enthalpy adjustment 2
specifications 9
standards 8
status LEDs 25
stop bits 51
superheated steam calculation 3
suppression, interference 21
system
 errors 59
 messages 59
 warnings 61

T

terminal designations 13
test menu 58
thermal expansion 90
timeout
 mode 56
 time 56
tm/log menu 52
TOTAL key 26
total, default 25

U

unit tag 30

units

 menu 38
units of measurement 5
upload application software 35

V

version, customer 86
view data logs 28, 29

W

warnings 61
watchdog timer (WDT) 30
weekly logging 54
wiring
 insulation 14
 mains power 14
 relays 14

Y

yearly logging 54